

FOR CAR USE ONLY/NUR FÜR AUTOMOBIL GEBRAUCH/POUR APPLICATION AUTOMOBILE UNIQUEMENT/PARA USO EN AUTOMÓVILES/SOLO PER L'UTILIZZO IN AUTOMOBILE/ENDAST FÖR BILBRUK/ALLEEN VOOR GEBRUIK IN DE AUTO/ ТОЛЬКО ДЛЯ ИСПОЛЬЗОВАНИЯ В АВТОМОБИЛЯХ/DO UŻYCIA TYLKO W SAMOCHODZIE/ΓΙΑ ΧΡΗΣΗ ΜΟΝΟ ΣΕ ΑΥΤΟΚΙΝΗΤΟ

# ALPINE®

## MP3/WMA/AAC CD Receiver CDE-123R



- OWNER'S MANUAL  
Please read before using this equipment.
- BEDIENUNGSANLEITUNG  
Lesen Sie diese Bedienungsanleitung bitte vor Gebrauch des Gerätes.
- MODE D'EMPLOI  
Veuillez lire avant d'utiliser cet appareil.
- MANUAL DE OPERACIÓN  
Léalo antes de utilizar este equipo.
- ISTRUZIONI PER L'USO  
Si prega di leggere prima di utilizzare il attrezzatura.
- ANVÄNDARHANDLEDNING  
Innan du använder utrustningen bör du läsa igenom denna användarhandledning.
- GEBRUIKERSHANDLEIDING  
Lees deze aanwijzingen aandachtig alvorens dit toestel te gebruiken.
- РУКОВОДСТВО ПО ЭКСПЛУАТАЦИИ  
Прочтите настоящее руководство перед началом использования оборудования.
- INSTRUKCJA OBSŁUGI  
Prosimy zapoznać się z tą instrukcją przed przystąpieniem do użytkowania urządzenia.
- ΕΓΧΕΙΡΙΔΙΟ ΧΡΗΣΗΣ  
Παρακαλούμε διαβάστε το πριν χρησιμοποιήσετε τη συσκευή.

#### ALPINE ELECTRONICS MARKETING, INC.

1-1-8 Nishi Gotanda,  
Shinagawa-ku,  
Tokyo 141-0031, Japan  
Phone 03-5496-8231

#### ALPINE ELECTRONICS OF AMERICA, INC.

19145 Gramercy Place, Torrance,  
California 90501, U.S.A.  
Phone 1-800-ALPINE-1 (1-800-257-4631)

#### ALPINE ELECTRONICS OF CANADA, INC.

777 Supertest Road, Toronto,  
Ontario M3J 2M9, Canada  
Phone 1-800-ALPINE-1 (1-800-257-4631)

#### ALPINE ELECTRONICS OF AUSTRALIA PTY. LTD.

161-165 Princes Highway, Hallam  
Victoria 3803, Australia  
Phone 03-8787-1200

#### ALPINE ELECTRONICS GmbH

Wilhelm-Wagenfeld-Str. 1-3, 80807 München, Germany  
Phone 089-32 42 640

#### ALPINE ELECTRONICS OF U.K. LTD.

Alpine House  
Fletchamstead Highway, Coventry CV4 9TW, U.K.  
Phone 0870-33 33 763

#### ALPINE ELECTRONICS FRANCE S.A.R.L.

(RCS PONTOISE B 338 101 280)  
98, Rue de la Belle Etoile, Z.I. Paris Nord II,  
B.P. 50016, 95945 Roissy Charles de Gaulle  
Cedex, France  
Phone 01-48638989

#### ALPINE ITALIA S.p.A.

Viale C. Colombo 8, 20090 Trezzano  
Sul Naviglio (MI), Italy  
Phone 02-484781

#### ALPINE ELECTRONICS DE ESPAÑA, S.A.

Portal de Gamarra 36, Pabellón, 32  
01013 Vitoria (Alava)-APDO 133, Spain  
Phone 945-283588

#### ALPINE ELECTRONICS (BENELUX) GmbH

Leuvensesteenweg 510-B6,  
1930 Zaventem, Belgium  
Phone 02-725-13 15

EN

DE

FR

ES

IT

SE

NL

RU

PL

GR



## Operating Instructions

### WARNING

WARNING .....	5
CAUTION .....	5
PRECAUTIONS .....	5

### Getting Started

Accessory List .....	8
Turning Power On and Off .....	8
Source Selection .....	8
Detaching and Attaching the Front Panel .....	8
Detaching .....	8
Attaching .....	8
Initial System Start-Up .....	8
Adjusting Volume .....	9
Setting the Dimmer Control .....	9

### Radio

Listening to Radio .....	9
Presetting Stations Manually .....	9
Presetting Stations Automatically .....	10
Tuning to Preset Stations .....	10
Frequency Search Function .....	10

### RDS

Turning AF (Alternative Frequencies) ON/OFF .....	10
Receiving RDS Regional (Local) Stations .....	11
PI SEEK Setting .....	11
Setting PTY31 (Emergency Broadcast) reception .....	11
Receiving Traffic Information .....	11
PTY (Programme Type) Tuning .....	12
Receiving Traffic Information While Playing CD or Radio .....	12
Priority News .....	12
Displaying Radio Text .....	12

### CD/MP3/WMA/AAC

Playback .....	13
Repeat Play .....	13
M.I.X. (Random Play) .....	13
Searching for CD Text .....	13
Folder/File Name Search (concerning MP3/WMA/AAC) .....	13
Folder Name Search mode .....	13

File Name Search mode .....	14
Quick Search .....	14
About MP3/WMA/AAC .....	14
Terminology .....	15

### Sound Setting

Adjusting Subwoofer Level/Bass Level/ Mid Level/Treble Level/Balance (Between Left and Right)/Fader (Between Front and Rear)/ AUX Mix Level/Loudness/Defeat .....	15
Sound Setting .....	16
Equalizer Presets (FACTORY EQ) .....	16
Adjusting the Parametric Equalizer Curve (3BAND EQ) .....	16
Setting the Bass Control .....	16
Setting the Mid Control .....	16
Setting the Treble Control .....	17
Adjusting the High Pass Filter .....	17
Turning Subwoofer ON/OFF .....	17
Adjusting the Low Pass Filter .....	17
Setting the Subwoofer Phase .....	17
Setting the Subwoofer System .....	17

### Other Functions

Displaying the Text .....	18
About the indication display .....	18
About "Text" .....	18
Using the Front AUX Input Terminal .....	18
Set your favourite source to the FAV button (FAV SETUP) .....	19
Set your favourite source .....	19
Recall your favourite source .....	19

### SETUP

Setting .....	19
BLUETOOTH Setting .....	20
Setting the BLUETOOTH Connection .....	20
Setting the BT Menu language .....	20
General Setting .....	20
Set your favourite source to the FAV button (FAV SETUP) .....	20
Playing MP3/WMA/AAC Data (PLAY MODE) .....	20
Turning Mute Mode On/Off (INT MUTE) .....	21
Setting the AUX REAR Setup Mode (AUX-R SET) .....	21
Setting the AUX SETUP Mode .....	21
Setting the AUX Level (AUX GAIN) .....	21
Setting the AUX REAR Level (AUX-R GAIN) .....	21
Setting the AUX MIX .....	21
Setting the Language (CYRILLIC) .....	21
Connecting to an External Amplifier (POWER IC) .....	22
Demonstration .....	22

Display Setting .....	22
Changing Lighting Colour .....	22
Scroll Type Setting .....	22
Scroll Setting (TEXT SCR) .....	23
Tuner Setting .....	23
Adjusting Source Signal Levels (FM-LEVEL) .....	23
iPod/iPhone and USB Setting .....	23
Setting the USB Search Mode .....	23
Setting the USB Skip function .....	23

## USB Memory/Portable audio player (optional)

Connecting the USB Memory (optional) .....	23
When connect USB Memory to Front USB	
Connection Terminal .....	23
Remove USB Memory from Front USB	
Connection Terminal .....	23
Using the USB Memory/Portable audio player	
Banking Function .....	24
Playback .....	24
Searching for a desired Song .....	24
Searching by Tag information .....	24
Searching by artist name .....	25
Searching by Explorer (FILE NAME) mode	
(Flash Memory only) .....	25
Repeat Play .....	25
M.I.X. (Random Play) .....	26
Select Playlist/Artist/Album/Genre/	
Composer/Folder .....	26
Alphabet Skip Function	
(Tag search mode only) .....	26
Quick Search .....	26
Search Position Memory .....	26

## iPod/iPhone (optional)

Connecting an iPod/iPhone .....	27
Setting the iPod Control .....	27
Playback .....	27
Searching for a desired Song .....	27
Direct Search Function .....	28
Select Playlist/Artist/Album/Genre/	
Composer/Episode .....	28
Alphabet Skip Function .....	28
Search Position Memory .....	29
Random Play Shuffle (M.I.X.) .....	29
Repeat Play .....	29
Displaying the Text .....	29

## Information

In Case of Difficulty .....	30
Basic .....	30
Radio .....	30
CD .....	30
MP3/WMA/AAC .....	30
Audio .....	30
iPod .....	30
Indication for CD Player .....	30
Indication for USB Memory/Portable audio	
player .....	31
Indication for iPod Mode .....	31
Specifications .....	32

## Installation and Connections

<b>WARNING</b> .....	<b>33</b>
<b>CAUTION</b> .....	<b>33</b>
<b>PRECAUTIONS</b> .....	<b>33</b>
Installation .....	34
Removal .....	34
iPod/iPhone Connection	
(sold separately) .....	34
When connect to Front USB Connection	
Terminal .....	35
When connect to Rear USB Connector .....	35
Remove the iPod/iPhone .....	35
Rear USB Memory Connection	
(sold separately) .....	35
Connect USB Memory .....	35
Remove USB Memory .....	35
Connections .....	36

# Operating Instructions

## WARNING

### WARNING

This symbol means important instructions. Failure to heed them can result in serious injury or death.

#### **DO NOT OPERATE ANY FUNCTION THAT TAKES YOUR ATTENTION AWAY FROM SAFELY DRIVING YOUR VEHICLE.**

Any function that requires your prolonged attention should only be performed after coming to a complete stop. Always stop the vehicle in a safe location before performing these functions. Failure to do so may result in an accident.

#### **KEEP THE VOLUME AT A LEVEL WHERE YOU CAN STILL HEAR OUTSIDE NOISES WHILE DRIVING.**

Excessive volume levels that obscure sounds such as emergency vehicle sirens or road warning signals (train crossings, etc.) can be dangerous and may result in an accident. LISTENING AT LOUD VOLUME LEVELS IN A CAR MAY ALSO CAUSE HEARING DAMAGE.

#### **DO NOT DISASSEMBLE OR ALTER.**

Doing so may result in an accident, fire or electric shock.

#### **USE ONLY IN CARS WITH A 12 VOLT NEGATIVE GROUND.**

(Check with your dealer if you are not sure.) Failure to do so may result in fire, etc.

#### **KEEP SMALL OBJECTS SUCH AS BATTERIES OUT OF THE REACH OF CHILDREN.**

Swallowing them may result in serious injury. If swallowed, consult a physician immediately.

#### **USE THE CORRECT AMPERE RATING WHEN REPLACING FUSES.**

Failure to do so may result in fire or electric shock.

#### **DO NOT BLOCK VENTS OR RADIATOR PANELS.**

Doing so may cause heat to build up inside and may result in fire.

#### **USE THIS PRODUCT FOR MOBILE 12V APPLICATIONS.**

Use for other than its designed application may result in fire, electric shock or other injury.

#### **DO NOT PLACE HANDS, FINGERS OR FOREIGN OBJECTS IN INSERTION SLOTS OR GAPS.**

Doing so may result in personal injury or damage to the product.

### CAUTION

This symbol means important instructions. Failure to heed them can result in injury or material property damage.

#### **HALT USE IMMEDIATELY IF A PROBLEM APPEARS.**

Failure to do so may cause personal injury or damage to the product. Return it to your authorized Alpine dealer or the nearest Alpine Service Centre for repairing.

### PRECAUTIONS

#### **Product Cleaning**

Use a soft dry cloth for periodic cleaning of the product. For more severe stains, please dampen the cloth with water only. Anything else has the chance of dissolving the paint or damaging the plastic.

#### **Temperature**

Be sure the temperature inside the vehicle is between +60°C (+140°F) and -10°C (+14°F) before turning your unit on.

#### **Moisture Condensation**

You may notice the CD playback sound wavering due to condensation. If this happens, remove the disc from the player and wait about an hour for the moisture to evaporate.

#### **Damaged Disc**

Do not attempt to play cracked, warped, or damaged discs. Playing a bad disc could severely damage the playback mechanism.

#### **Maintenance**

If you have problems, do not attempt to repair the unit yourself. Return it to your Alpine dealer or the nearest Alpine Service Station for servicing.

#### **Never Attempt the Following**

Do not grip or pull out the disc while it is being pulled back into the player by the automatic reloading mechanism.

Do not attempt to insert a disc into the unit when the unit power is off.

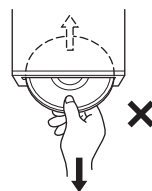

#### **Inserting Discs**

Your player accepts only one disc at a time for playback. Do not attempt to load more than one disc.

Make sure the label side is facing up when you insert the disc. "ERROR" will be displayed on your player if you insert a disc incorrectly. If "ERROR" continues to be displayed even though the disc has been inserted correctly, push the RESET switch with a pointed object such as a ballpoint pen.

Playing a disc while driving on a very bumpy road may result in skips, but this will not scratch the disc or damage the player.

---

## New Discs

To prevent the CD from jamming, "ERROR" is displayed if discs with irregular surfaces are inserted or if discs are inserted incorrectly. When a new disc is ejected immediately after initial loading, use your finger to feel around the inside of the centre hole and outside edge of the disc. If you feel any small bumps or irregularities, this could inhibit proper loading of the disc. To remove the bumps, rub the inside edge of the hole and outside edge of the disc with a ballpoint pen or other such instrument, then insert the disc again.

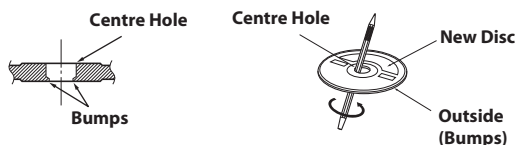

---

## Irregular Shaped Discs

Be sure to use round shape discs only for this unit and never use any special shape discs. Use of special shape discs may cause damage to the mechanism.



---

## Installation Location

Make sure this unit will not be installed in a location subjected to:

- Direct sun and heat
- High humidity and water
- Excessive dust
- Excessive vibrations

---

## Correct Handling

Do not drop the disc while handling. Hold the disc so you will not leave fingerprints on the surface. Do not affix tape, paper, or gummed labels to the disc. Do not write on the disc.

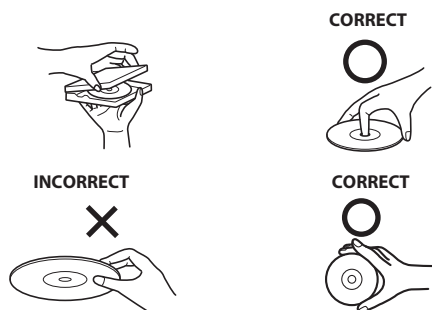

---

## Disc Cleaning

Fingerprints, dust, or soil on the surface of the disc could cause the CD player to skip. For routine cleaning, wipe the playing surface with a clean, soft cloth from the centre of the disc to the outer edge.

If the surface is heavily soiled, dampen a clean, soft cloth in a solution of mild neutral detergent before cleaning the disc.



---

## Disc Accessories

There are various accessories available on the market for protecting the disc surface and improving sound quality. However, most of them will influence the thickness and/or diameter of the disc. Using such accessories can cause the disc to be out of standard specifications and may create operational problems. We recommend not using these accessories on discs played in Alpine CD players.

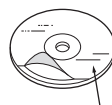

Transparent Sheet

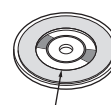

Disc Stabilizer

---

## On handling Compact Discs (CD/CD-R/CD-RW)

- Do not touch the surface.
- Do not expose the disc to direct sunlight.
- Do not affix stickers or labels.
- Clean the disc when it is dusty.
- Make sure that there are no bumps around the disc.
- Do not use commercially available disc accessories.

**Do not leave the disc in the car or the unit for a long time. Never expose the disc to direct sunlight.** Heat and humidity may damage the CD and you may not be able to play it again.

---

## To customers using CD-R/CD-RW

- If a CD-R/CD-RW cannot be played back, make sure the last recording session was closed (finalised).
- Finalize the CD-R/CD-RW if necessary, and attempt playback again.

---

## About media that can be played

Use only compact discs with the label side showing the CD logo marks below.



If you use non-standard compact discs, correct performance cannot be guaranteed.

You can play CD-Rs (CD-Recordables)/CD-RWs (CD-ReWritables) which have been recorded only on audio devices. You can also play CD-Rs/CD-RWs containing MP3 formatted audio files.

- Some of the following CDs may not play on this unit: Flawed CDs, CDs with fingerprints, CDs exposed to extreme temperatures or sunlight (e.g., left in the car or this unit), CDs recorded under unstable conditions, CDs on which a recording failed or a re-recording was attempted, copy-protected CDs which do not conform to the audio CD industry standard.
- Use discs with compressed audio files written in a format compatible with this unit. For details, refer to "About MP3/WMA/AAC" on page 14.
- Data files, other than audio, on the disc are ignored and are not played back.

---

## Protecting the USB Connection Terminal

- Only USB Flash Memory devices, Portable audio player or iPod/iPhone can be connected to the USB connection terminal on this unit. Correct performance using other USB products cannot be guaranteed. A USB hub is not supported.
- Do not connect Flash Memory over 20 mm wide to front USB terminal.  
Also, avoid connecting Flash Memory to the front USB terminal and connecting Front Aux at the same time.
- If a USB device is inserted in the unit, it projects out and may be a danger while driving.  
Use a commercially available USB extension cable, and connect it in a safe way.
- Depending on the connected Flash Memory device, the unit may not function or some functions may not be performed.
- The audio file format that can be played back on the unit is MP3/WMA/AAC.
- Artist/song name, etc., can be displayed, however characters may not be correctly displayed.

---

## On Handling USB Flash Memory

### CAUTION

**Alpine accepts no responsibility for lost data, etc., even if data, etc., is lost while using this product.**

- To prevent malfunction or damage, note the following points.  
Read the Flash Memory Owner's Manual thoroughly.
- Fix the USB Memory in a location where driver operation will not be hindered.
- Flash Memory may not function correctly at high or low temperature.
- Use only certified USB Flash Memory Devices. Please pay attention that even certified USB Memory, may not function correctly depending on its type or state.
- Flash Memory function is not guaranteed. Use Flash Memory according to the terms of agreement.
- Depending on the settings of the Flash Memory type, memory state or encoding software, the unit may not play back or display properly.
- A file that is copy-protected (copyright protection) cannot be played back.
- Flash Memory may take time to start playback. If there is a particular file other than audio in the Flash Memory, it may take considerable time before the file is played back or searched.
- The unit can play back "mp3", "wma" or "m4a" file extensions.
- Do not add the above extensions to a file other than audio data. This non-audio data will not be recognised. The resulting playback may contain noise that can damage speakers and/or amplifiers.
- It is recommended to back up important data on a personal computer.
- Do not remove the USB device while playback is in progress. Change SOURCE to something other than USB, then remove the USB device to prevent possible damage to its memory.

---

## On Handling Portable audio player

- The unit can control a Portable audio player with the USB interface.  
Playable audio file formats are MP3 and WMA.
- Portable audio player function is not guaranteed. Use Portable audio player according to the terms of agreement. Read the Portable audio player Owner's Manual thoroughly.
- Fix the Portable audio player in a location where driver operation will not be hindered.
- Portable audio player may not function correctly at high or low temperature.
- Depending on the settings of the Portable audio player type, memory state or encoding software, the unit may not play back or display properly.
- If the Portable audio player has an MSC/MTP setting, set to MTP.

- A Portable audio player in which data is stored by USB Mass Storage may not be playable on the unit.
- Depending on the Portable audio player settings, USB Mass Storage may be supported. For setting, refer to the Owner's Manual of the player.
- The unit can play back MP3/WMA files synchronized by Windows Media Player (Ver. 7, 8, 9), and are then forwarded to the player. The "mp3" or "wma" extensions are playable.
- If data is not synchronized by Windows Media Player and is forwarded in another way, the unit may not be able to correctly play back the files.
- A file that is copy-protected (copyright protection) cannot be played back.
- It is recommended to back up important data on a personal computer.
- Do not remove the USB device while playback is in progress. Change SOURCE to something other than USB, then remove the USB device to prevent possible damage to its memory.
- When Nokia is used as a Portable audio player:  
Not all the Nokia mobile phones can be used as Portable audio players. If the Nokia phone fails to work as a Portable audio player while connected, set it to Mass Storage mode and reconnect to this unit. For details, refer to Owner's Manual of the Nokia phone.

- *Windows Media, and the Windows logo are trademarks, or registered trademarks of Microsoft Corporation in the United States and/or other countries.*
- *iPhone, iPod, iPod classic, iPod nano, and iPod touch are trademarks of Apple Inc., registered in the U.S. and other countries.*
- *"Made for iPod," and "Made for iPhone," mean that an electronic accessory has been designed to connect specifically to iPod, or iPhone, respectively, and has been certified by the developer to meet Apple performance standards. Apple is not responsible for the operation of this device or its compliance with safety and regulatory standards.*
- *The BLUETOOTH® word mark and logos are registered trademarks owned by the Bluetooth SIG, Inc. and any use of such marks by Alpine Electronics, Inc. is under license.*
- *"MPEG Layer-3 audio coding technology licensed from Fraunhofer IIS and Thomson."*
- *"Supply of this product only conveys a licence for private, non-commercial use and does not convey a license nor imply any right to use this product in any commercial (i.e. revenue-generation) real time broadcasting (terrestrial, satellite, cable and/or any other media), broadcasting/streaming via internet, intranets and/or other networks or in other electronic content distribution systems, such as pay-audio or audio-on-demand applications. An independent license for such use is required. For details, please visit <http://www.mp3licensing.com>"*

# Getting Started

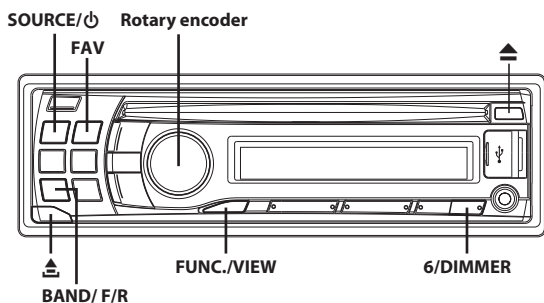

## Accessory List

- Head Unit .....1
- Power Cable .....1
- USB Cable .....1
- Mounting Sleeve .....1
- Carrying Case .....1
- Rubber Cap .....1
- Hex Bolt .....1
- Screw (M5 × 8) .....4
- Owner's Manual .....1 set

## Turning Power On and Off

Press SOURCE/⏻ to turn on the unit.

### Note

- The unit can be turned on by pressing any other button except ▲ and △ (Release).

Press and hold SOURCE/⏻ for at least 2 seconds to turn off the unit.

### Note

- The first time power is turned on, the volume will start from level 12.

## Source Selection

Press SOURCE/⏻ to change the source.

TUNER → DISC → USB FRONT\*<sup>1</sup>/iPod FRONT\*<sup>2</sup> → BT AUDIO\*<sup>3</sup> → AUXILIARY\*<sup>4</sup> → TUNER

- \*1 Displayed only when no iPod/iPhone is connected. During USB FRONT source, you can switch to USB REAR source by pressing BAND/F/R.
- \*2 Displayed only when the iPod/iPhone is connected. During iPod FRONT source, you can switch to iPod REAR source by pressing BAND/F/R when an iPod/iPhone is connected to Rear USB Connector.
- \*3 Displayed only when BT IN is set to HFP+AUDIO, refer to "Setting the BLUETOOTH Connection" on page 20.
- \*4 Refer to "Using the Front AUX Input Terminal" on page 18. During AUX source, you can switch to AUX REAR source by pressing BAND/F/R when ON is set in "Setting the AUX REAR Setup Mode (AUX-R SET)" (refer to "Setting the AUX REAR Setup Mode (AUX-R SET)" on page 21).

### Note

- You can recall your favourite source by pressing FAV directly. For details, refer to "Set your favourite source to the FAV button (FAV SETUP)" on page 19.

## Detaching and Attaching the Front Panel

### Detaching

- 1 Turn off the unit power.
- 2 Press ▲ (Release) at the lower left side until the front panel pops out.
- 3 Grasp the left side of the front panel and pull it out.

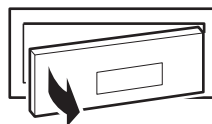

### Notes

- The front panel may become hot in normal usage (especially the connector terminals on the back of the front panel). This is not a malfunction.
- To protect the front panel, place it in the supplied carrying case.
- When detaching the front panel, do not apply excessive force as it may result in malfunction.

### Attaching

- 1 Insert the right side of the front panel into the main unit. Align the groove on the front panel with the projections on the main unit.
- 2 Push the left side of the front panel until it locks firmly into the main unit.

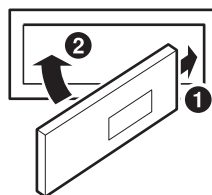

### Notes

- Before attaching the front panel, make sure that there is no dirt or dust on the connector terminals and no foreign object between the front panel and the main unit.
- Attach the front panel carefully, holding the sides of the front panel to avoid pushing buttons by mistake.

## Initial System Start-Up

Be sure to press the RESET switch when using the unit for the first time, after changing the car battery, etc.

- 1 Turn off the unit power.
- 2 Remove the detachable front panel.



- Press **RESET** with a ballpoint pen or similar pointed object.

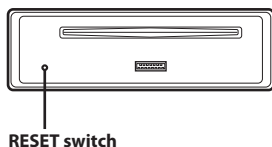

## Adjusting Volume

Turn the **Rotary encoder** until the desired sound is obtained.

## Setting the Dimmer Control

- Press and hold **FUNC./VIEW** for at least 2 seconds so that the **◀F▶** indicator lights up.

- Press and hold **6/DIMMER** for at least 2 seconds repeatedly to select the **DIMMER** mode.

DIMMER A (Auto mode) → DIMMER ON → DIMMER OFF → DIMMER A

### **DIMMER A mode:**

Decrease the illumination brightness of the unit with the head lights of the vehicle ON. This mode is useful if you feel the unit's backlighting is too bright at night.

### **DIMMER ON mode:**

Keep the illumination brightness of the unit dark.

### **DIMMER OFF mode:**

Keep the illumination brightness of the unit bright.

- Press and hold **FUNC./VIEW** for at least 2 seconds to activate the normal mode.

The **◀F▶** indicator goes out.

### Notes

- Operate the unit while the **◀F▶** indicator lights up. If no operation is performed for 5 seconds, the **◀F▶** indicator goes out.
- The function is inoperable when the **ILLUMINATI** is set to other than **TYPE1**, refer to "Changing Lighting Colour" on page 22.

### Controllable with Remote Control

This unit can be controlled with an optional Alpine remote control. For details, consult your Alpine dealer.

Point the optional remote control transmitter at the remote control sensor.

Remote control sensor

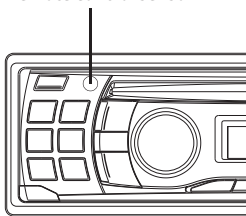

### Connectable to Remote Control Interface Box

This unit may be controlled from the vehicle's audio controls. An optional Alpine Remote Control Interface Box must be used. For details, contact your Alpine dealer.

# Radio

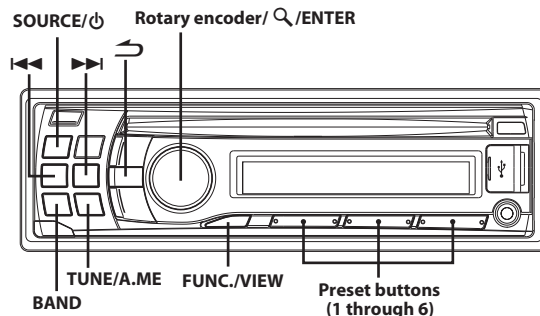

## Listening to Radio

- Press **SOURCE/⏻** to select **TUNER** mode.
- Press **BAND** repeatedly until the desired radio band is displayed.

F1 (FM1) → F2 (FM2) → F3 (FM3) → MW → LW → F1 (FM1)

- Press **TUNE/A.ME** to select the tuning mode.

DX SEEK (Distance mode) → SEEK (Local mode) → OFF (Manual mode) → DX SEEK

### **Note**

- The initial mode is Distance mode.

### **Distance mode:**

Both strong and weak stations will be automatically tuned in (Automatic Seek Tuning).

### **Local mode:**

Only strong stations will be automatically tuned in (Automatic Seek Tuning).

### **Manual mode:**

The frequency is manually tuned in steps (Manual tuning).

- Press **◀◀** or **▶▶** to tune in the desired station.

Holding down **◀◀** or **▶▶** will change the frequency continuously.

## Presetting Stations Manually

While receiving the station that you want to store, press and hold, for at least 2 seconds, any one of the **preset buttons (1 through 6)** into which you wish to store the station.

The display shows the band, preset number and station frequency memorised.

### Notes

- A total of 30 stations can be stored in the preset memory (6 stations for each band; FM1, FM2, FM3, MW and LW).
- If you store a station in a preset memory which already has a station, the current station will be cleared and replaced with the new station.
- If the **◀F▶** indicator is illuminated, turn off the indicator by pressing and holding **FUNC./VIEW** for at least 2 seconds, and then you can perform the operation.

## Presetting Stations Automatically

- 1 Press **BAND** repeatedly until the desired radio band is displayed.
- 2 Press and hold **TUNE/A.ME** for at least 2 seconds.  
The frequency on the display continues to change while the automatic memory is in progress. The tuner will automatically seek and store 6 strong stations in the selected band. They will be stored into preset buttons 1 to 6 in order of signal strength. When the automatic memory has been completed, the tuner goes to the station stored in preset location No.1.

### Note

- If no stations are stored, the tuner will return to the original station you were listening to before the auto memory procedure began.

## Tuning to Preset Stations

Select the band, and then press any one of the station preset buttons (1 through 6) that has your desired radio station in memory.

The display shows the band, preset number and frequency of the station selected.

### Note

- If the **◀F▶** indicator is illuminated, turn off the indicator by pressing and holding **FUNC./VIEW** for at least 2 seconds, and then you can perform the operation.

## Frequency Search Function

You can search for a radio station by its frequency.

- 1 Press and hold **Q/ENTER** for at least 2 seconds in Radio mode to activate Frequency search mode.
- 2 Turn the **Rotary encoder** to select the desired frequency.
- 3 Press **Q/ENTER** to receive the selected frequency.

### Note

- Press **↶** in the search mode to cancel. Or, the search mode will be cancelled if no operation is performed for 10 seconds.

## RDS

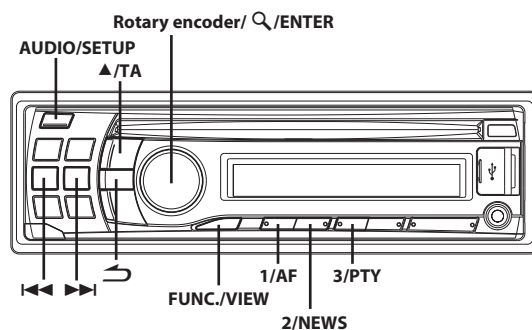

## Turning AF (Alternative Frequencies) ON/OFF

The RDS (Radio Data System) is a radio information system using the 57 kHz subcarrier of regular FM broadcast. The RDS allows you to receive a variety of information such as traffic information, station names, and to automatically re-tune to a stronger transmitter that is broadcasting the same programme.

- 1 Press and hold **FUNC./VIEW** for at least 2 seconds so that the **◀F▶** indicator lights up.
- 2 Press **1/AF** to select the AF (Alternative Frequency) ON or OFF mode.
- 3 Press and hold **FUNC./VIEW** for at least 2 seconds to activate the normal mode.  
The **◀F▶** indicator goes out.

### Notes

- When the AF ON mode is selected, the unit automatically tunes to a strong signal station in the AF list.
- Use the AF OFF mode when automatic re-tuning is not required.
- When the PTY31 (Emergency Broadcast) reception is set to on (refer to "Setting PTY31 (Emergency Broadcast) reception" on page 11), if the unit receives the PTY31 (Emergency Broadcast) signal, the unit will show "ALARM" in the display automatically.
- Operate the unit while the **◀F▶** indicator lights up. If no operation is performed for 5 seconds, the **◀F▶** indicator goes out.

The RDS digital data includes the following:

PI	Programme Identification
PS	Programme Service Name
AF	List of Alternative Frequencies
TP	Traffic Programme
TA	Traffic Announcement
EON	Enhanced Other Networks

---

## Receiving RDS Regional (Local) Stations

---

- 1 Press and hold **AUDIO/SETUP** for at least 2 seconds to activate the **SETUP** mode.
- 2 Turn the **Rotary encoder** to select the **TUNER** mode, and then press **Q/ENTER**.  
BLUETOOTH\* ↔ GENERAL ↔ AUDIO ↔ DISPLAY ↔ TUNER ↔ iPod & USB  
*\* Displayed only when INT MUTE is OFF, and the mode is set to other than BT AUDIO.*
- 3 Turn the **Rotary encoder** to select the **RDS REG** mode, and then press **Q/ENTER**.
- 4 Turn the **Rotary encoder** to select **ON** or **OFF**.  
In the **OFF** mode, the unit automatically keeps receiving the related local RDS station.
- 5 Press and hold **AUDIO/SETUP** for at least 2 seconds to return to normal mode.

### Notes

- Press **↶** to return to the previous mode.
- If no operation is performed for 60 seconds, the unit will return to normal mode automatically.

---

## PI SEEK Setting

---

- 1 Press and hold **AUDIO/SETUP** for at least 2 seconds to activate the **SETUP** mode.
- 2 Turn the **Rotary encoder** to select the **TUNER** mode, and then press **Q/ENTER**.  
BLUETOOTH\* ↔ GENERAL ↔ AUDIO ↔ DISPLAY ↔ TUNER ↔ iPod & USB  
*\* Displayed only when INT MUTE is OFF, and the mode is set to other than BT AUDIO.*
- 3 Turn the **Rotary encoder** to select the **PI SEEK** mode, and then press **Q/ENTER**.
- 4 Turn the **Rotary encoder** to select **ON** or **OFF**.
- 5 Press and hold **AUDIO/SETUP** for at least 2 seconds to return to normal mode.

### Notes

- Press **↶** to return to the previous mode.
- If no operation is performed for 60 seconds, the unit will return to normal mode automatically.

---

## Setting PTY31 (Emergency Broadcast) reception

---

Turn PTY31 (Emergency Broadcast) reception ON/OFF.

- 1 Press and hold **AUDIO/SETUP** for at least 2 seconds to activate the **SETUP** mode.
- 2 Turn the **Rotary encoder** to select the **TUNER** mode, and then press **Q/ENTER**.  
BLUETOOTH\* ↔ GENERAL ↔ AUDIO ↔ DISPLAY ↔ TUNER ↔ iPod & USB  
*\* Displayed only when INT MUTE is OFF, and the mode is set to other than BT AUDIO.*
- 3 Turn the **Rotary encoder** to select **ALARM**, and then press **Q/ENTER**.
- 4 Turn the **Rotary encoder** to select **ON** or **OFF**.  
If you set to **ON**, emergency broadcasts are received regardless of source. "ALARM" is displayed during reception.
- 5 Press and hold **AUDIO/SETUP** for at least 2 seconds to return to normal mode.  
When an emergency broadcast is received, the volume level will be automatically changed to the memorized level in the traffic information mode. For details, refer to "Receiving Traffic Information" on page 11.

### Notes

- Pressing **↶** during the procedure will return to the previous mode.
- If no operation is performed for 60 seconds in the **SETUP** mode, the setting mode is cancelled.

---

## Receiving Traffic Information

---

- 1 Press and hold **▲/TA** for at least 2 seconds so that the "TA" indicator lights up.
- 2 Press **◀◀** or **▶▶** to select your desired traffic information station.  
When a traffic information station is tuned in, the "TP" indicator lights up.  
Traffic information is heard only when it is being broadcast. If traffic information is not being broadcast, the unit is set in the standby mode. When a traffic information broadcast begins, the unit automatically receives it and the display shows "T INFO".  
When the traffic information broadcast is over, the unit will automatically set in the standby mode.

### Notes

- If the traffic information broadcast signal falls below a certain level, the unit remains in the receiving mode for 1 minute. If the signal remains below a certain level for over 1 minute, the "TA" indicator blinks.
- If you do not want to listen to the traffic information being received, lightly press **◀◀** or **▶▶** to skip that traffic information message. The TA mode will remain in the ON position to receive the next traffic information message.
- If the volume level is changed while receiving traffic information, the changed volume level will be memorized. When traffic information is received next time, the volume level will be automatically adjusted to the level memorized.
- In the TA mode, the SEEK tuning selects only the TP stations.

---

## PTY (Programme Type) Tuning

---

- 1 Press and hold **FUNC./VIEW** for at least 2 seconds so that the **◀F▶** indicator lights up.
- 2 Press **3/PTY** to activate the PTY mode, while the unit is in Radio (FM receiving) mode.  
The Programme Type of the station being currently received will be displayed for 5 seconds.  
If there is no receivable PTY broadcast, "NO PTY" will be displayed for 5 seconds.  
If no RDS station can be received, the display shows "NO PTY".  
**Note**
  - If no operation is performed for 5 seconds after pressing **3/PTY**, the PTY mode will be automatically cancelled.
- 3 Press **◀◀** or **▶▶** within 5 seconds after activating the PTY mode to choose the desired programme type while the PTY (programme type) is being displayed.  
Each press scrolls the programme type by one.
- 4 Press **3/PTY** within 5 seconds after selecting the programme type to start searching for a station in the selected programme type.  
The chosen programme type display blinks during searching and lights when a station is found.  
If no PTY station is found, "NO PTY" will be displayed for 5 seconds.
- 5 Press and hold **FUNC./VIEW** for at least 2 seconds to activate the normal mode.  
The **◀F▶** indicator goes out.

### Note

- Operate the unit while the **◀F▶** indicator lights up. If no operation is performed for 5 seconds, the **◀F▶** indicator goes out.

---

## Receiving Traffic Information While Playing CD or Radio

---

- 1 Press and hold **▲/TA** for at least 2 seconds so that the "TA" indicator lights up.
- 2 Press **◀◀** or **▶▶** to select a traffic information station if necessary.  
When a traffic information broadcast starts, the unit automatically mutes the CD player or the regular FM broadcast. When the traffic information broadcast finishes, the unit automatically returns to the original source play before the traffic information broadcast began.

### When traffic information stations cannot be received:

#### In the CD mode:

When the TP signal can no longer be received, the traffic information station of another frequency will be selected automatically.

### Note

- The receiver is equipped with the EON (Enhanced Other Networks) function in order to keep track of additional alternate frequencies to the AF list. If the station being received does not broadcast the traffic information, the receiver automatically tunes in the related station that broadcasts the traffic information when it occurs.

- 3 Press and hold **▲/TA** for at least 2 seconds to deactivate the Traffic Information mode.  
The "TA" indicator goes out.

---

## Priority News

---

This function allows you to preset to give priority to the News programme. You will never miss the News programme as the unit automatically gives priority to the News programme whenever it begins broadcasting, and interrupts the programme you are currently listening. This feature is functional when your unit is set to a mode other than the LW and MW modes.

- 1 Press and hold **FUNC./VIEW** for at least 2 seconds to activate the function mode while the unit is in Radio (FM receiving) mode.
- 2 Press **2/NEWS** to activate the PRIORITY NEWS mode.  
To disable the PRIORITY NEWS function, press **2/NEWS**.  
**Note**
  - In the PRIORITY NEWS function, unlike in the TA function, the volume does not increase automatically.
- 3 Press and hold **FUNC./VIEW** for at least 2 seconds to activate the preset mode, while the unit is in Radio (FM receiving) mode.  
The **◀F▶** indicator goes out.

### Note

- Operate the unit while the **◀F▶** indicator lights up. If no operation is performed for 5 seconds, the **◀F▶** indicator goes out.

---

## Displaying Radio Text

---

Text messages from a radio station can be displayed.

Press **VIEW** while receiving FM in the radio mode to select the Radio Text display.

The display will change every time the button is pressed. For details, refer to "Displaying the Text" on page 18.

# CD/MP3/WMA/AAC

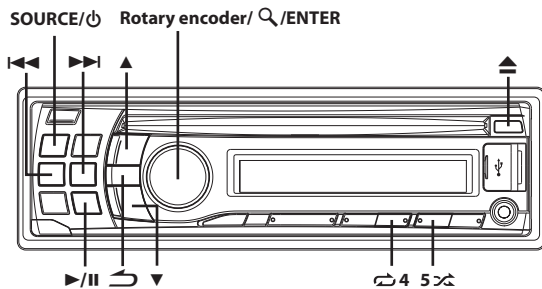

## Playback

- 1 Insert a disc with the label side facing up.  
The disc will be pulled into the unit automatically.

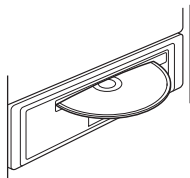

### Note

- When a disc is already inserted, press SOURCE/⏻ to switch to the DISC mode.

- 2 While playing back MP3/WMA/AAC, press ▼ or ▲ to select the desired folder.
- 3 Press ⏪ or ⏩ to select the desired track (file).  
Pressing and holding ⏪ or ⏩ will fast backward/fast forward track continuously.
- 4 To pause playback, press ▶||. Pressing ▶|| again will resume playback.
- 5 To eject the disc, press ▲.

### Notes

- Do not remove a CD during its eject cycle. Do not load more than one disc at a time. A malfunction may result from doing either.
- The “🔍” indicator lights up when a disc is inserted.
- Three-inch (8 cm) CDs can not be used.
- WMA format files that are protected by DRM (Digital Rights Management), AAC format files that have been purchased from the iTunes Store and files that are copy-protected (copyright protection) cannot be played back on this unit.
- The track display for MP3/WMA/AAC data playback is the file numbers recorded on the disc.
- The playback time may not be correctly displayed when a VBR (Variable Bit Rate) recorded file is played back.

## Repeat Play

- 1 Press 4. The song is played back repeatedly.  
🔍\*1 → 🔍\*2 → (off) → 🔍  
\*1 Only a track is repeatedly played back.  
\*2 Only files in a folder are repeatedly played back. (MP3/WMA/AAC mode only)
- 2 To cancel repeat play, select (off) with the above procedure.

## M.I.X. (Random Play)

- 1 Press 5. The songs are played back in random sequence.  
🔍\*1 → 🔍 ALL\*2 → (off) → 🔍  
\*1 Only files in a folder are played back in random sequence. (MP3/WMA/AAC mode only)  
\*2 The tracks/files are played back in random sequence.
- 2 To cancel M.I.X. play, select (off) with the above procedure.

## Searching for CD Text

On discs utilizing CD Text, songs can be searched and played by using their recorded titles. For discs without CD Text, searches are made using the track numbers associated with each song.

- 1 Press 🔍/ENTER during play.  
This will set the search mode, and the “🔍” indicator lights up.
- 2 Turn the Rotary encoder to select the desired track, and then press 🔍/ENTER.  
This will play the selected track.

### Notes

- Press 🔍 in the search mode to cancel. Or, the search mode is cancelled if no operation is performed for 60 seconds.
- When CD Text Search is made during M.I.X. play, the M.I.X. play mode will be cancelled.

## Folder/File Name Search (concerning MP3/WMA/AAC)

Folder and file names may be searched and displayed during playback.

### Folder Name Search mode

- 1 During MP3/WMA/AAC playback, press 🔍/ENTER to activate the search mode.  
The “🔍” indicator lights up.
- 2 Turn the Rotary encoder to select Folder Name Search mode, and then press 🔍/ENTER.
- 3 Turn the Rotary encoder to select the desired folder.

#### 4 Press and hold **Q** / **ENTER** for at least 2 seconds to play back the first file in the selected folder.

##### Notes

- Press and hold **↵** for at least 2 seconds in the search mode to cancel. Or, the search mode is cancelled if no operation is performed for 60 seconds.
- To search for files in the Folder Name Search mode, press **Q** / **ENTER**. Files in the folder may be searched.
- Press **↵** to exit Folder Name Search mode in step 3 in order to select File Name Search mode.
- The root folder is displayed as "ROOT".
- When Folder Name Search is made during M.I.X. play, the M.I.X. play mode will be cancelled.

## File Name Search mode

#### 1 During MP3/WMA/AAC playback, press **Q** / **ENTER** to activate the search mode.

The "Q" indicator lights up.

#### 2 Turn the Rotary encoder to select File Name Search mode, and then press **Q** / **ENTER**.

#### 3 Select the desired file by turning the Rotary encoder.

#### 4 Press **Q** / **ENTER** to play back the selected file.

##### Notes

- Press and hold **↵** for at least 2 seconds in the search mode to cancel. Or, the search mode is cancelled if no operation is performed for 60 seconds.
- Press **↵** in the search mode to return to the previous mode.
- When File Name Search is made during M.I.X. play, the M.I.X. play mode will be cancelled.

## Quick Search

You can search for tracks (files).

#### 1 Press and hold **Q** / **ENTER** for at least 2 seconds in the CD/MP3/WMA/AAC mode to activate Quick Search mode.

The "Q" indicator lights up.

#### 2 Turn the Rotary encoder to select a desired track (file), and then press **Q** / **ENTER**.

The selected track is played back immediately.

##### Note

- Press **↵** in the search mode to cancel. Or, the search mode is cancelled if no operation is performed for 10 seconds.

## About MP3/WMA/AAC

### CAUTION

Except for private use, duplicating audio data (including MP3/WMA/AAC data) or distributing, transferring, or copying it, whether for free or for a fee, without permission of the copyright holder is strictly prohibited by the Copyright Act and by international treaty.

##### What is MP3?

MP3, whose official name is "MPEG-1 Audio Layer 3," is a compression standard prescribed by the ISO, the International Standardization Organization and MPEG which is a joint activity institution of the IEC.

MP3 files contain compressed audio data. MP3 encoding is capable of compressing audio data at extremely high ratios, reducing the size of music files to as much as one-tenth their original size. This is achieved while still maintaining near CD quality. The MP3 format realises such high compression ratios by eliminating the sounds that are either inaudible to the human ear or masked by other sounds.

##### What is WMA?

WMA, or "Windows Media™ Audio," is compressed audio data. WMA is similar to MP3 audio data and can achieve CD quality sound with small file sizes.

##### What is AAC?

AAC is the abbreviation for "Advanced Audio Coding," and is a basic format of audio compression used by MPEG2 or MPEG4.

##### Method for creating MP3/WMA/AAC files

Audio data is compressed using software with MP3/WMA/AAC codecs. For details on creating MP3/WMA/AAC files, refer to the user's manual for that software.

MP3/WMA/AAC files that are playable on this device have the file extensions "mp3" / "wma" / "m4a". Files with no extension cannot be played back (WMA ver. 7.1, 8 and 9 are supported). Protected files are not supported, neither are raw AAC files (using the ".aac" extension). There are many different versions of the AAC format. Confirm that the software being used conforms to the acceptable formats listed above. It's possible that the format may be unplayable even though the extension is valid.

Playback of AAC files encoded by iTunes is supported.

##### Supported playback sampling rates and bit rates

###### MP3

Sampling rates: 48 kHz, 44.1 kHz, 32 kHz, 24 kHz, 22.05 kHz, 16 kHz, 12 kHz, 11.025 kHz, 8 kHz

Bit rates: 8 - 320 kbps

###### WMA

Sampling rates: 48 kHz, 44.1 kHz, 32 kHz

Bit rates: 48 - 192 kbps

###### AAC

Sampling rates: 48 kHz, 44.1 kHz, 32 kHz, 24 kHz, 22.05 kHz, 16 kHz, 12 kHz, 11.025 kHz, 8 kHz

Bit rates: 16 - 320 kbps

This device may not play back correctly depending on sampling rates.

##### ID3 tags/WMA tags

This device supports ID3 tag v1 and v2, and WMA tag.

If tag data is in an MP3/WMA/AAC file, this device can display the title (track title), artist name, and album name ID3 tag/WMA tag data.

This device can only display single-byte alphanumeric characters (up to 30 for ID3 tags and up to 15 for WMA tags) and the underscore. For non-supported characters, "NO SUPPORT" is displayed.

If information contains characters other than ID3 tag information, the audio file may not be played back.

The tag information may not be correctly displayed, depending on the contents.

##### Producing MP3/WMA/AAC discs

MP3/WMA/AAC files are prepared, then written to a CD-R or CD-RW using CD-R writing software. A disc can hold up to 510 files/folders (including Root Folders), and the maximum number of folders is 255. Playback may not be performed if a disc exceeds the limitations described above.

##### Media supported

The media that this device can play back are CD-ROMs, CD-Rs, and CD-RWs.

##### Corresponding File Systems

This device supports discs formatted with ISO9660 Level 1 or Level 2. Under the ISO9660 standard, there are some restrictions to remember. The maximum nested folder depth is 8 (including the root directory). The number of characters for a folder/file name is limited. Valid characters for folder/file names are letters A-Z (all caps), numbers 0-9, and '\_' (underscore).

This device also can play back discs in Joliet, Romeo, etc., and other standards that conform to ISO9660. However, sometimes the file names, folder names, etc., are not displayed correctly.

### Formats supported

This device supports CD-ROW XA, Mixed Mode CD, Enhanced CD (CD-Extra) and Multi-Session.  
This device cannot correctly play back discs recorded with Track At Once or packet writing.

### Order of files

Files are played back in the order that the writing software writes them to the disc. Therefore, the playback order may not be what is expected. Verify the writing order in the software's documentation. The playback order of the folders and files is as follows.

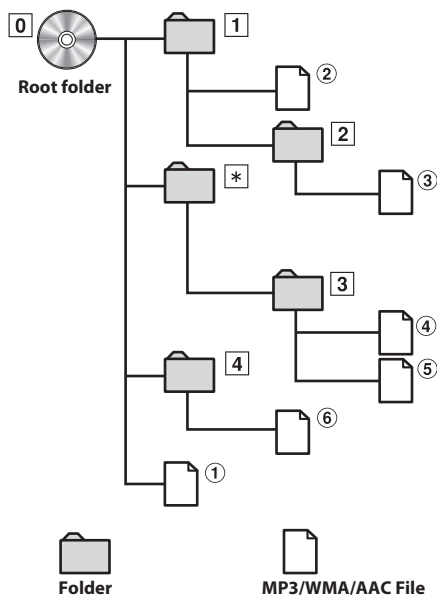

\* The folder No./ folder Name will not be displayed if no file is contained in the folder.

## Terminology

### Bit rate

This is the "sound" compression rate specified for encoding. The higher the bit rate, the higher the sound quality, but also the larger the files.

### Sampling rate

This value shows how many times per second the data is sampled (recorded). For example, music CDs use a sampling rate of 44.1 kHz, so the sound is sampled (recorded) 44,100 times per second. The higher the sampling rate, the higher the sound quality, but also the larger the volume of data.

### Encoding

Converting music CDs, WAVE (AIFF) files, and other sound files into the specified audio compression format.

### Tag

Song information such as track titles, artist names, album names, etc., written into MP3/WMA/AAC files.

### Root folder

The root folder (or root directory) is found at the top of the file system. The root folder contains all folders and files. It is created automatically for all burned discs.

## Sound Setting

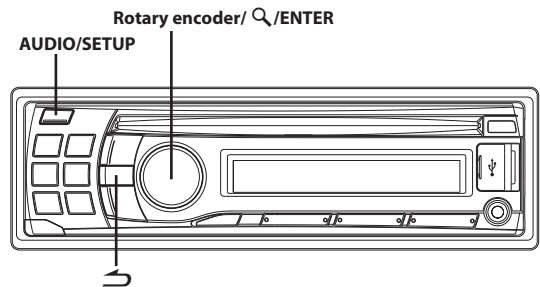

## Adjusting Subwoofer Level/Bass Level/Mid Level/Treble Level/Balance (Between Left and Right)/Fader (Between Front and Rear)/AUX Mix Level/Loudness/Defeat

### 1 Press AUDIO repeatedly to choose the desired mode.

Each press changes the mode as follows:

SUBW<sup>\*1</sup> → BASS<sup>\*2</sup> → MID<sup>\*2</sup> → TREBLE<sup>\*2</sup> → BAL → FAD → AUX MIX<sup>\*3</sup> → LOUD<sup>\*2</sup> → DEFEAT → VOLUME → SUBW

- \*1 When the subwoofer mode is set to OFF, its level cannot be adjusted, refer to "Turning Subwoofer ON/OFF" on page 17.
- \*2 Adjustable only when DEFEAT is OFF.
- \*3 Adjustable only when AUX MIX is ON (refer to "Setting the AUX MIX" on page 21).

Subwoofer	0 ~ +15
Bass level	-7 ~ +7
Mid level	-7 ~ +7
Treble level	-7 ~ +7
Balance	L15 ~ R15
Fader	R15 ~ F15
AUX Mix level	0 ~ 15
Loudness	ON/OFF
Defeat	ON/OFF
Volume	0 ~ 35

### Notes

- If no operation is performed for 5 seconds, the unit automatically returns to normal mode.
- Loudness introduces a special low- and high-frequency emphasis at low listening levels. This compensates for the ear's decreased sensitivity to bass and treble sound.

### 2 Turn the Rotary encoder until the desired sound is obtained in each mode.

By setting DEFEAT ON, previously adjusted level settings of BASS, MID, and TREBLE will return to the factory defaults.

## Sound Setting

You can flexibly customize the unit to suit your own preference and usage. From the AUDIO SETUP menu, Audio Setting can be modified.

**Use steps 1 to 5 to select one of the setting modes to modify. See the applicable section below for details about the selected setting item.**

- 1 Press and hold **AUDIO/SETUP** for at least 2 seconds to activate the **SETUP** mode.
- 2 Turn the **Rotary encoder** to select **AUDIO**, and then press **Q/ENTER**.  
BLUETOOTH\*1 ↔ GENERAL ↔ AUDIO ↔ DISPLAY ↔ TUNER ↔ iPod & USB  
*\*1 Displayed only when INT MUTE is set to OFF, and the mode is set to other than BT AUDIO.*
- 3 Turn the **Rotary encoder** to select the desired sound setting menu, and then press **Q/ENTER**.  
FACTORY EQ\*2/\*3 ↔ 3BAND EQ\*2/\*4 ↔ HPF\*2 ↔ SUBWOOFER ↔ SUBW LPF\*5 ↔ SUBW PHASE\*5 ↔ SUBW SYS\*5  
*\*2 Adjustment cannot be performed when DEFEAT is set to ON.  
\*3 The FACTORY EQ's setting value and 3BAND EQ's setting value are linkage.  
\*4 The FACTORY EQ's setting value and 3BAND EQ's setting value are linkage. In step 3, three sound adjustment items (Bass, Mid and Treble) can be selected in 3BAND EQ mode, turn the **Rotary encoder** to select the desired item, and then press **Q/ENTER** to continue to step 4.  
\*5 These functions are inoperable when Subwoofer is set to OFF.*
- 4 Turn the **Rotary encoder** to change the setting, and then press **Q/ENTER**.  
(e.g. Select SUBWOOFER ON or SUBWOOFER OFF)
- 5 Press and hold **AUDIO/SETUP** for at least 2 seconds to return to normal mode.

### Notes

- Pressing **↶** returns to the previous Sound menu mode.
- If no operation is performed for 60 seconds, Sound menu mode is cancelled.

## Equalizer Presets (FACTORY EQ)

10 typical equalizer settings are preset at the factory for a variety of musical source material.

USER ↔ FLAT ↔ POPS ↔ ROCK ↔ NEWS ↔ JAZZ ↔ ELEC DANCE ↔ HIP HOP ↔ EASY LIS ↔ COUNTRY ↔ CLASSICAL

## Adjusting the Parametric Equalizer Curve (3BAND EQ)

You can modify the Equalizer settings to create a response curve more appealing to your personal taste. The setting of Bass, Mid and Treble can be adjusted in this mode.

### Setting the Bass Control

- 1 After selecting **BASS** from the 3BAND EQ adjustment mode, turn the **Rotary encoder** to select the desired Bass setting item, and then press **Q/ENTER**.  
WIDTH (Q) ↔ CENTER FRQ ↔ LEVEL

- 2 Turn the **Rotary encoder** to select the desired setting value, and then press **Q/ENTER**.
- 3 Press **↶** to return to the previous step.

#### Setting the Bass Bandwidth (WIDTH (Q))

Turn the **Rotary encoder** to select the desired bass bandwidth.

WIDE 0.50 ↔ MEDIUM 1.00 ↔ MEDIUM 1.50 ↔ NARROW 2.00

Changes the boosted bass bandwidth to wide or narrow. A wider setting will boost a wide range of frequencies above and below the centre frequency. A narrower setting will boost only frequencies near the centre frequency.

#### Setting the Bass Centre Frequency (CENTER FRQ)

Turn the **Rotary encoder** to select the desired bass centre frequency.

60 (Hz) ↔ 80 (Hz) (Initial setting) ↔ 100 (Hz) ↔ 120 (Hz)

Emphasises the displayed bass frequency ranges.

#### Setting the Bass Level

Turn the **Rotary encoder** to select the desired bass level (-7~+7)\*.

You can emphasise or weaken the bass level.

\* The adjustment can also be made by pressing **AUDIO**. Refer to "Adjusting Subwoofer Level/Bass Level/Mid Level/Treble Level/Balance (Between Left and Right)/Fader (Between Front and Rear)/AUX Mix Level/Loudness/Defeat" on page 15.

### Setting the Mid Control

- 1 After selecting **MID** from the 3BAND EQ adjustment mode, turn the **Rotary encoder** to select the desired Mediant setting item, and then press **Q/ENTER**.  
WIDTH (Q) ↔ CENTER FRQ ↔ LEVEL
- 2 Turn the **Rotary encoder** to select the desired setting value, and then press **Q/ENTER**.
- 3 Press **↶** to return to the previous step.

#### Setting the Mid Bandwidth (WIDTH (Q))

Turn the **Rotary encoder** to select the desired Mid bandwidth.

WIDE 0.75 ↔ MEDIUM 1.00 ↔ MEDIUM 1.25 ↔ NARROW 1.50

#### Setting the Mid Centre Frequency (CENTER FRQ)

Turn the **Rotary encoder** to select the desired Mid centre frequency.

500 (Hz) ↔ 1.0k (Hz) (Initial setting) ↔ 1.5k (Hz) ↔ 2.5k (Hz)

#### Setting the Mid Level

Turn the **Rotary encoder** to select the desired Mid level (-7~+7)\*.

You can emphasise or weaken the Mid level.

\* The adjustment can also be made by pressing **AUDIO**. Refer to "Adjusting Subwoofer Level/Bass Level/Mid Level/Treble Level/Balance (Between Left and Right)/Fader (Between Front and Rear)/AUX Mix Level/Loudness/Defeat" on page 15.



## Setting the Treble Control

1 After selecting **TREBLE** from the **3BAND EQ** adjustment mode, turn the **Rotary encoder** to select the desired **Treble** setting item, and then press **Q/ENTER**.

WIDTH (Q) ↔ CENTER FRQ ↔ LEVEL

2 Turn the **Rotary encoder** to select the desired setting value, and then press **Q/ENTER**.

3 Press **↶** to return to the previous step.

### Setting the Treble Bandwidth (WIDTH (Q))

Turn the **Rotary encoder** to select the desired **treble bandwidth**.

WIDE 0.75 ↔ NARROW 1.25

### Setting the Treble Centre Frequency (CENTER FRQ)

Turn the **Rotary encoder** to select the desired **treble centre frequency**.

7.5K (Hz) ↔ 10.0K (Hz) (Initial setting) ↔ 12.5K (Hz) ↔ 15.0K (Hz)

### Setting the Treble Level

Turn the **Rotary encoder** to select the desired **treble level** (-7~+7)\*.

You can emphasise or weaken the treble level.

\* The adjustment can also be made by pressing **AUDIO**. Refer to "Adjusting Subwoofer Level/Bass Level/Mid Level/Treble Level/Balance (Between Left and Right)/Fader (Between Front and Rear)/AUX Mix Level/Loudness/Defeat" on page 15.

## Adjusting the High Pass Filter

The High Pass Filter on this unit can be adjusted to suit your personal taste.

### Setting item: HPF

#### Setting contents:

OFF (Initial setting) / 60 (Hz) / 80 (Hz) / 120 (Hz) / 160 (Hz)

All frequencies above the selected cutoff are output.

## Turning Subwoofer ON/OFF

When the subwoofer is on, you can adjust the subwoofer output level (refer to "Adjusting Subwoofer Level/Bass Level/Mid Level/Treble Level/Balance (Between Left and Right)/Fader (Between Front and Rear)/AUX Mix Level/Loudness/Defeat" on page 15).

### Setting item: SUBWOOFER

#### Setting contents:

ON (Initial setting) / OFF

#### ON:

The subwoofer signal is output from the Subwoofer RCA Connectors (refer to "Connections" on page 36).

#### OFF:

No subwoofer signal is output from the Subwoofer RCA Connectors (refer to "Connections" on page 36).

## Adjusting the Low Pass Filter

The Low Pass Filter on this unit can be adjusted to suit your personal taste.

### Setting item: SUBW LPF

#### Setting contents:

OFF (Initial setting) / LPF 60 (Hz) / LPF 80 (Hz) / LPF 120 (Hz) / LPF 160 (Hz)

All frequencies lower than the selected cutoff are output.

## Setting the Subwoofer Phase

The subwoofer output phase is toggled **SUBWOOFER NORMAL** (0°) or **SUBWOOFER REVERSE** (180°). To adjust the level, turn the **Rotary encoder**.

### Setting item: SUBW PHASE

#### Setting contents:

NORMAL (Initial setting) / REVERSE

## Setting the Subwoofer System

When the subwoofer is on, you can select either **SYS 1** or **SYS 2** for the desired subwoofer effect.

### Setting item: SUBW SYS

#### Setting contents:

SUBW SYS 1 (Initial setting) / SUBW SYS 2

#### SUBW SYS 1:

Subwoofer level changes according to the main volume setting.

#### SUBW SYS 2:

Subwoofer level change is different from the main volume setting. For example, even at low volume settings, the subwoofer is still audible.

# Other Functions

SOURCE/⏻ Rotary encoder/↵/ENTER

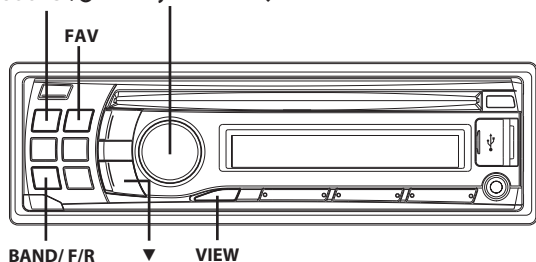

## Displaying the Text

Text information, such as the disc name and the track name, will be displayed if playing a CD text compatible disc. It is also possible to display the folder name, the file name and the tag, etc., while playing MP3/WMA/AAC files.

### Press VIEW.

The display will change every time the button is pressed.

### Note

- When the TEXT SCR is set to SCR MANUAL, press and hold ▼ for at least 2 seconds, the current text will be scrolled one time (except Radio mode).

### The display in Radio mode:

If there is PS (Programme Service Name)

PS (Programme Service Name) → PTY (Programme Type) → RADIO TEXT → PS (Programme Service Name)

If there is no PS (Programme Service Name)

FREQUENCY → PTY (Programme Type) → RADIO TEXT → FREQUENCY

### The display in CD mode:

TRACK NO./ELAPSED TIME → TEXT (DISC NAME)<sup>\*1</sup> → TEXT (TRACK NAME)<sup>\*1</sup> → TRACK NO./ELAPSED TIME

### The display in MP3/WMA/AAC mode:

FILE NO./ELAPSED TIME → (FOLDER NO./FILE NO.)<sup>\*2</sup> → FOLDER NAME → FILE NAME → ARTIST NAME<sup>\*3</sup> → ALBUM NAME<sup>\*3</sup> → SONG NAME<sup>\*3</sup> → FILE NO./ELAPSED TIME

<sup>\*1</sup> Displayed during playback of a disc with CD text.

<sup>\*2</sup> Only for MP3/WMA/AAC disc mode.

<sup>\*3</sup> ID3 tag/WMA tag

If an MP3/WMA/AAC file contains ID3 tag/WMA tag information, the ID3 tag/WMA tag information is displayed (e.g., song name, artist name, and album name). All other tag data is ignored.

## About the indication display

When displaying Text, the following indicators are lit according to the mode.

Indicator/ Mode	CD Mode	MP3/WMA/ AAC/USB AUDIO Mode	iPod/iPhone Mode
	—	Folder Name <sup>*2</sup> being displayed	—
	—	Artist Name <sup>*1</sup> being displayed	Artist Name <sup>*1</sup> being displayed

Indicator/ Mode	CD Mode	MP3/WMA/ AAC/USB AUDIO Mode	iPod/iPhone Mode
	Text (Disc Name <sup>*3</sup> ) being displayed	Album Name <sup>*1</sup> being displayed	Album Name <sup>*1</sup> being displayed
	Text (Track Name <sup>*3</sup> ) being displayed	Song Name <sup>*1</sup> / File Name being displayed	Song Name <sup>*1</sup> being displayed

<sup>\*1</sup> Tag information:

If there is no tag information, "ARTIST"/"ALBUM"/"SONG" is displayed.

<sup>\*2</sup> The root folder is displayed as "\ROOT".

<sup>\*3</sup> If there is no Text (Disc Name or Track Name), "DISC TEXT"/"TRACK TEXT" is displayed.

## About "Text"

Text compatible CDs contain text information such as the disc name and track name. Such text information is referred to as "text".

### Notes

- Some characters may not be displayed correctly with this device, depending on the character type.
- "NO SUPPORT" is displayed when the desired text information cannot be displayed on this unit.
- The text or tag information may not be correctly displayed, depending on the contents.

## Using the Front AUX Input Terminal

Connect a portable music player, etc. by simply connecting it to the input on the front panel. An optional adapter cable is required (standard RCA to 3.5ø mini-phonos plug or 3.5ø to 3.5ø mini-phonos plug).

Press SOURCE/⏻, and select the AUXILIARY mode to listen to the portable device.

Portable player, etc.

Main unit

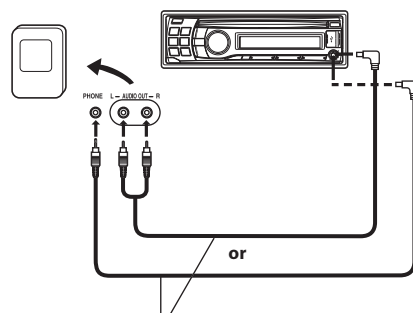

Optional adapter cable (RCA pin plugs [red, white] 3.5ø miniplugs) or (3.5ø miniplugs).

### Notes

- This function is available only when AUX SETUP is set to ON. For details, refer to "Setting the AUX SETUP Mode" on page 21.
- During AUX source, you can switch to AUX REAR source by pressing BAND/F/R. For details on AUX REAR, refer to "Setting the AUX REAR Setup Mode (AUX-R SET)" on page 21.
- If a Flash Memory Device is directly connected to the front USB terminal, the size or shape may interfere with driving operations, therefore, avoid connecting an AUX input terminal and a Flash Memory Device at the same time.

## Set your favourite source to the FAV button (FAV SETUP)

You can set a favourite source to the FAV button by following steps. Once this is set, you can switch to favourite source directly by pressing FAV.

### Set your favourite source

- 1 Press and hold **FAV** for at least 2 seconds to activate FAV setup mode.
- 2 Turn the **Rotary encoder** to select a favourite source, and then press **Q/ENTER**.  
The favourite source is set.

#### Notes

- If you do not want to use this function, select "OFF".
- If no operation is performed for 10 seconds, the unit automatically returns to normal mode.

### Recall your favourite source

Once a source is set to FAV button, press FAV to recall the source directly.

#### Note

- Depending on the setting, even though you set a source to FAV, it may not be available. For example, when you set AUX as your favourite source and OFF is set in "Setting the AUX SETUP Mode" (refer to "Setting the AUX SETUP Mode" on page 21), the AUX source will not be recalled by pressing FAV.

## SETUP

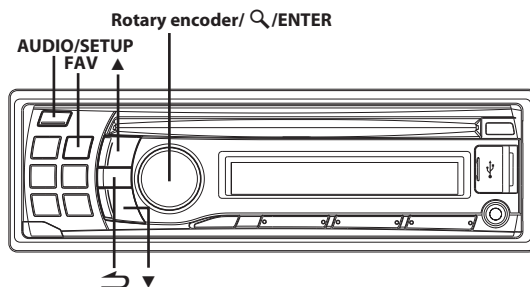

## Setting

You can flexibly customize the unit to suit your own preferences and usage. From the SETUP menu, GENERAL Setting, DISPLAY Setting, etc., can be modified.

Use steps 1 to 5 to select one of the SETUP modes to modify. See the applicable section below for details about the selected SETUP item.

- 1 Press and hold **AUDIO/SETUP** for at least 2 seconds to activate the SETUP mode.
- 2 Turn the **Rotary encoder** to select the desired item, and then press **Q/ENTER**.

BLUETOOTH\*1 ↔ GENERAL ↔ AUDIO\*2 ↔ DISPLAY ↔ TUNER ↔ iPod & USB  
(e.g. Select GENERAL)

**BLUETOOTH:**  
BT IN ↔ BT MENU\*3

**GENERAL:**  
FAV SETUP\*4 ↔ PLAY MODE ↔ INT MUTE\*5 ↔ AUX-R SET ↔ AUX-R NAME\*6 ↔ AUX SETUP ↔ AUX NAME\*7 ↔ AUX GAIN\*7 ↔ AUX-R GAIN\*6 ↔ AUX MIX\*7 ↔ CYRILLIC ↔ POWER IC ↔ DEMO

**DISPLAY:**  
ILLUMINATI ↔ SCROLLTYPE ↔ TEXT SCR

**TUNER:**  
RDS REG\*8 ↔ PI SEEK\*9 ↔ ALARM\*10 ↔ FM-LEVEL

**iPod & USB:**  
USB SEARCH ↔ USB SKIP

\*1 Displayed only when INT MUTE is set to OFF, and the mode is set to other than BT AUDIO.

\*2 Refer to "Sound Setting" on page 16.

\*3 Not displayed when BT IN is set to OFF.

\*4 You can also set this in "Set your favourite source to the FAV button (FAV SETUP)" (refer to "Set your favourite source to the FAV button (FAV SETUP)" on page 19).

\*5 Displayed only when BT IN is OFF.

\*6 Displayed only when AUX-R SET is set to ON.

\*7 Displayed only when AUX SETUP is set to ON.

\*8 Refer to "Receiving RDS Regional (Local) Stations" on page 11.

\*9 Refer to "PI SEEK Setting" on page 11.

\*10 Refer to "Setting PTY31 (Emergency Broadcast) reception" on page 11.

**3** Turn the **Rotary encoder** to select a setting item, and then press **Q/ENTER**.

(e.g. Select POWER IC)

**4** Turn the **Rotary encoder** to change the setting, and then press **Q/ENTER**.

(e.g. Select POWER IC ON or POWER IC OFF.)

**5** Press and hold **AUDIO/SETUP** for at least 2 seconds to return to normal mode.

#### Notes

- Press **↶** to return to the previous mode.
- If no operation is performed for 60 seconds, the unit will return to normal mode automatically.

## BLUETOOTH Setting

Select BLUETOOTH from the setup main menu in step 2 above.

### Setting the BLUETOOTH Connection

If an optional BLUETOOTH INTERFACE is connected, you can place a hands-free call by a BLUETOOTH-equipped mobile phone. Make this setting when the BLUETOOTH INTERFACE is connected and the BLUETOOTH function is used. For details, refer to the Owner's Manual of the optional BLUETOOTH INTERFACE.

#### Setting item: BT IN

##### Setting contents:

OFF (Initial setting) / HFP / HFP+AUDIO

##### OFF:

This option does not allow this unit to recognize connection with BLUETOOTH INTERFACE.

##### HFP:

Set this item when BLUETOOTH INTERFACE (KCE-250BT) is connected. (Hands-free Phone is available, but the BT Audio source is not displayed.)

##### HFP+AUDIO:

Set this item when BLUETOOTH INTERFACE (KCE-400BT) is connected. (Hands-free Phone is available, and BT Audio source is also available.)

#### Notes

- After the above setting, turn the ignition key off (ACC OFF) and on again (ACC ON).
- The **↶** button can be used only when the optional BLUETOOTH INTERFACE is connected.
- If the mobile phone compatible with the Voice Dial function is connected, the Voice Dial function can be used.
- When INT MUTE is set to ON, the BLUETOOTH setting cannot be made. When the BLUETOOTH INTERFACE is connected, set INT MUTE to OFF. Refer to "Turning Mute Mode On/Off (INT MUTE)" on page 21.

### Setting the BT Menu language

The BT Menu can be switched within 6 languages.

#### Setting item: BT MENU

##### Setting contents:

ENGLISH / DEUTSCH / FRANCAIS / ESPANOL / ITALIANO / NEDERLANDS

When an optional BLUETOOTH INTERFACE is connected, the display language for Phone Menu (recorded for the last dialed/received/missed calls and Phone Book/Voice Dial) will be changed depending on this setting.

When "BT MENU" is set to "ENGLISH", the Phone Menu is displayed as:

VOICE DIAL/DIALLED/RECEIVED/MISSED/PHONE BOOK

When "BT MENU" is set to "DEUTSCH", the Phone Menu is displayed as:

SPRACHWAHL/GEWAEHLT/ANGENOMMEN/VERPASST/TEL-BUCH

When "BT MENU" is set to "FRANCAIS", the Phone Menu is displayed as:

CP-VOCAL/COMPOSES/RECUS/MANQUES/REPERTOIRE

When "BT MENU" is set to "ESPANOL", the Phone Menu is displayed as:

MARC VOCAL/REALIZADAS/RECIBIDAS/PERDIDAS/AGENDA

When "BT MENU" is set to "ITALIANO", the Phone Menu is displayed as:

C VOCALE/EFFETTUAATE/RICEVUTE/PERSE/RUBRICA

When "BT MENU" is set to "NEDERLANDS", the Phone Menu is displayed as:

VOICE DIAL/GEKOZEN/ONTVANGEN/GEMISTE/TEL BOEK

## General Setting

GENERAL is selected on the setup main menu in step 2.

### Set your favourite source to the FAV button (FAV SETUP)

You can select one source as your favourite source. Once this is set, you can switch to favourite source directly by pressing **FAV**.

USB FRONT ↔ USB REAR ↔ FM1 ↔ FM2 ↔ FM3 ↔ LW ↔ MW ↔ AUX ↔ AUX REAR ↔ DISC ↔ BT AUDIO ↔ FAV OFF

#### Notes

- Depending on the setting, some item may not selectable.
- If you do not want to use this function, select "FAV OFF".
- This setting can also be activated by pressing and holding **FAV** for at least 2 seconds. For details, refer to "Set your favourite source to the FAV button (FAV SETUP)" on page 19.

### Playing MP3/WMA/AAC Data (PLAY MODE)

This unit can play back CDs containing both CD and MP3/WMA/AAC data (created in Enhanced CD (CD Extra) format). However, in some situations, playback of an enhanced CD may be difficult. In this case, you can select playback of a single session only, containing the CD data. When a disc contains both CD and MP3/WMA/AAC data, playback starts from the CD data portion of the disc.

#### Setting item: PLAY MODE

##### Setting contents:

CD-DA (Initial setting) / CDDA/MP3

##### CD-DA:

Only the CD data in Session 1 can be played back.

##### CDDA/MP3:

CD data, MP3/WMA/AAC files in mixed mode, and multi-session discs can be played back.

#### Note

- Perform this setting before inserting a disc. If a disc has already been inserted, remove it first.

## Turning Mute Mode On/Off (INT MUTE)

If a device having the interrupt feature is connected, audio will be automatically muted whenever the interrupt signal is received from the device.

### Setting item: INT MUTE

#### Setting contents:

OFF AUX (Initial setting) / OFF AUX-R / ON

#### OFF AUX:

When the interrupt signal is received from device, the AUX source volume will be output from the unit.

#### OFF AUX-R:

When the interrupt signal is received from device, the AUX REAR source volume will be output from the unit.

#### ON:

When the interrupt signal is received from device, no sound will be output.

## Setting the AUX REAR Setup Mode (AUX-R SET)

You can input the audio of an external device, (such as a Portable audio player) to the BLUETOOTH interface connector of this unit. A special Conversion cable (KCE-237B) is necessary to adapt the BLUETOOTH interface connector as an AUX IN.

A portable music device and a BLUETOOTH INTERFACE cannot be connected to the BLUETOOTH interface connector at the same time.



### Setting item: AUX-R SET

#### Setting contents:

ON / OFF (Initial setting)

#### ON:

Set to ON when a portable device is connected. If SOURCE /  is pressed and AUX REAR is selected, the sound of the portable device is input to the unit.

\* You can change the AUX-R NAME display when AUX-R SET is set to ON. Press  / ENTER when AUX-R SET is set to ON, and select AUX-R NAME by turning the **Rotary encoder**, then press  / ENTER. After that, turn the **Rotary encoder** to select the desired AUX-R NAME.

#### Note

- When the PORTABLE is set, PMD is displayed on the unit.

#### OFF:

When set to OFF, AUX REAR source cannot be selected.

## Setting the AUX SETUP Mode

You can input the audio of an external device, (such as a Portable audio player) to the AUX connector of this unit.



### Setting item: AUX SETUP

#### Setting contents:

ON (Initial setting) / OFF

#### ON:

Set to ON when a portable device is connected. If SOURCE /  is pressed and AUX is selected, the sound of the portable device is input to the unit.

\* You can change the AUX NAME display when AUX SETUP is set to ON. Press  / ENTER when AUX SETUP is set to ON, and select AUX NAME by turning the **Rotary encoder**, then press  / ENTER. After that, turn the **Rotary encoder** to select the desired AUX NAME.

#### Note

- When the PORTABLE is set, PMD is displayed on the unit.

#### OFF:

When set to OFF, AUX source cannot be selected.

## Setting the AUX Level (AUX GAIN)

After setting to ON in “Setting the AUX SETUP Mode”, this setting can be carried out.

### Setting item: AUX GAIN

#### Setting contents:

LOW (Initial setting) / HIGH

#### LOW:

Decreases the external input audio level.

#### HIGH:

Increases the external input audio level.

## Setting the AUX REAR Level (AUX-R GAIN)

After setting to ON in “Setting the AUX REAR Setup Mode”, this setting can be carried out.

### Setting item: AUX-R GAIN

#### Setting contents:

LOW / HIGH (Initial setting)

#### LOW:

Decreases the external input audio level.

#### HIGH:

Increases the external input audio level.

## Setting the AUX MIX

With an external audio device connected to the front AUX terminal of CDE-123R, the voice from external device will be mixed with the radio or CD, etc. play.

### Setting item: AUX MIX

#### Setting contents:

OFF (Initial setting) / ON

#### Notes

- Noise may be more noticeable when this function is not used. In this case, the OFF setting is recommended.
- This setting is effective when AUX SETUP is ON.

## Setting the Language (CYRILLIC)

Set the language to be displayed on the unit.

### Setting item: CYRILLIC

#### Setting contents:

OFF (Initial setting) / ON

#### OFF:

English, Latin character

#### ON:

Russian, English

**Note**

- Refer to the table below for the Russian display on this unit.

Таблица символов для русского языка							
D: Дисплей							
C: СИМВОЛ							
D	C	D	C	D	C	D	C
А	А	Б	Б	В	В	Г	Г
Д	Д	Е	Е,Ё	Ж	Ж	З	З
И	И,Й	К	К	Л	Л	М	М
Н	Н	О	О	П	П	Р	Р
С	С	Т	Т	У	У	Ф	Ф
Х	Х	Ц	Ц	Ч	Ч	Ш,Щ	Ш,Щ
'	Ъ	Ы	Ы	Ь	Ь	Э	Э
Ю	Ю	Я	Я				

**Connecting to an External Amplifier (POWER IC)**

When an external amplifier is connected, sound quality can be improved by stopping the power supply of the built-in amplifier.

**Setting item: POWER IC**

**Setting contents:**

ON (Initial setting) / OFF

**ON:**

The speakers are driven by the built-in amplifier.

**OFF:**

Use this mode when the line output of this unit is used to drive an external amplifier. In this setting, the head unit's internal amplifier is turned OFF and cannot drive speakers.

**ON:**

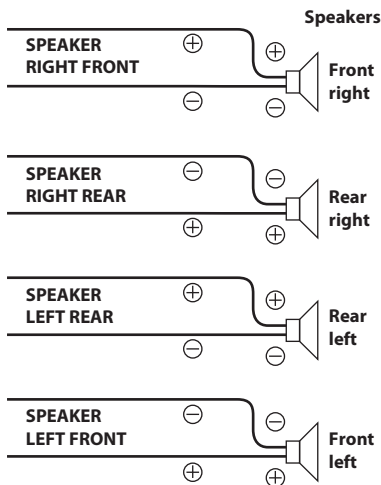

**OFF:**

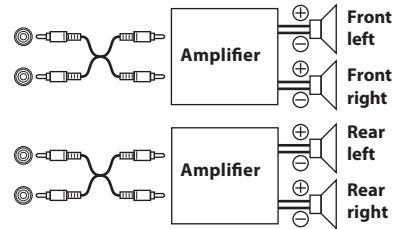

**Note**

- No sound is produced by the system when the power output is set to OFF.

**Demonstration**

This unit has a demonstration feature for the display.

**Setting item: DEMO**

**Setting contents:**

DEMO ON / DEMO OFF (Initial setting)

**Note**

- To quit Demo mode, set to DEMO OFF.

**Display Setting**

DISPLAY is selected on the setup main menu in step 2.

**Changing Lighting Colour**

You can change the lighting colour of the following six buttons.

SOURCE / , FAV, , , BAND and .

**Setting item: ILLUMINATI**

**Setting contents:**

ILUM TYPE1 (Initial setting) / TYPE2 /TYPE3 / TYPE4

**TYPE1:**

When the colour of the six buttons is blue, the colour of the other is red.

**TYPE2:**

When the colour of the six buttons is green, the colour of the other is green.

**TYPE3:**

When the colour of the six buttons is amber, the colour of the other is red.

**TYPE4:**

When the colour of the six buttons is red, the colour of the other is red.

**Scroll Type Setting**

Choose from two scrolling methods.

Select the type you prefer.

**Setting item: SCROLLTYPE**

**Setting contents:**

SCR TYPE1 / SCR TYPE2 (Initial setting)

**SCR TYPE1:**

The characters scroll from right to left, a single character at a time.

**SCR TYPE2:**

Words are built up from left to right, a single character at a time. When the display is filled, it is cleared and the remaining words are displayed the same way until all words of the title have been shown.

## Scroll Setting (TEXT SCR)

This CD player can scroll the disc and track names recorded on CD-TEXT discs, as well as the text information of MP3/WMA/AAC files, folder names and tags.

### Setting item: TEXT SCR

#### Setting contents:

SCR AUTO / SCR MANUAL (Initial setting)

#### SCR AUTO:

The current text information of CD, folder, tag, etc. is scrolled automatically.

#### SCR MANUAL:

The display is scrolled when a disc is loaded or when a track is changed, etc.

#### Note

- The unit scrolls CD text names, folder names, file names or tag display.

## Tuner Setting

TUNER is selected on the setup main menu in step 2.

## Adjusting Source Signal Levels (FM-LEVEL)

If the difference in volume level between the CD player and FM radio is too great, adjust the FM signal level.

### Setting item: FM-LEVEL

#### Setting contents:

FM-LV HIGH (Initial setting) / FM-LV LOW

## iPod/iPhone and USB Setting

"iPod & USB" is selected on the setup main menu in step 2.

## Setting the USB Search Mode

The unit allows you to search for the USB Audio files by Tag information or Explorer (FILE NAME) mode.

### Setting item: USB SEARCH

#### Setting contents:

TAG (Initial setting) / FILE NAME

#### TAG:

When TAG is selected, you can use Playlists/Artists/Albums/Songs/Genres/Composers/Folders/Files search mode to narrow searches.

#### FILE NAME:

When FILE NAME is selected, you can search a folder/file as search files on PC.

#### Notes

- After the above setting, turn the ignition key off (ACC OFF) and on again (ACC ON).
- For search mode details, refer to "Searching for a desired Song" on page 24.

## Setting the USB Skip function

During Explorer (FILE NAME) searching, you can skip over designated folders/files by pressing ▲/▼. For example, if you select 10FILE in the Explorer (FILE NAME) searching mode, by pressing ▲ you can skip forward 10 folders/files from the current folder/file; by pressing ▼ you can skip backward 10 folders/files from the current folder/file. If the folders/files searched are less than the assigned skipped-over ones, pressing ▲/▼ will skip to the first or last folder/file.

### Setting item: USB SKIP

#### Setting contents:

10FILE (Initial setting) / 20FILE / 50FILE / 100FILE

## USB Memory/Portable audio player (optional)

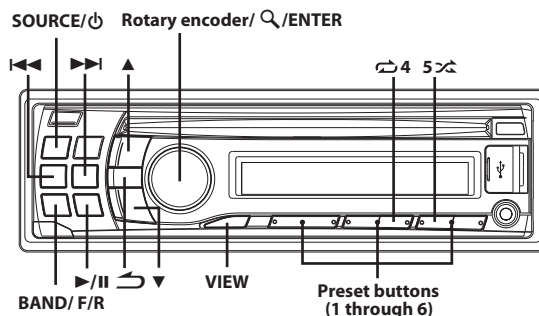

## Connecting the USB Memory (optional)

If a USB Memory device/Portable audio player is connected to the unit, MP3/WMA/AAC files can be played back.

#### Note

- When TAG is set in "Setting the USB Search Mode" (refer to "Setting the USB Search Mode" on page 23), in the USB mode, when this unit is reset, ACC is switched from OFF to ON, or when the USB is connected to this unit, "BANKING" is displayed for several seconds.

There are two USB connectors on this unit, you can choose to connect an USB Memory to Front USB Connection Terminal or Rear USB Connector.

## When connect USB Memory to Front USB Connection Terminal

- Open the cover of the USB Connection Terminal.
- Connect the USB Memory directly to the USB Connection Terminal, or via the USB cable.

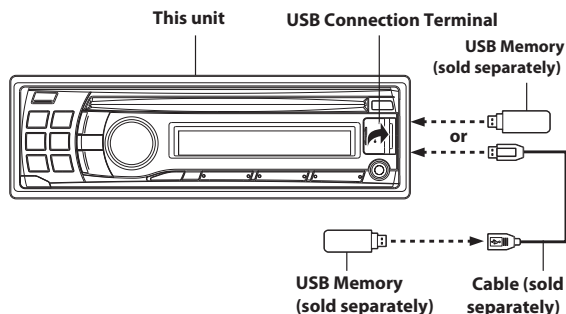

## Remove USB Memory from Front USB Connection Terminal

- Carefully, pull out the USB Memory from the USB cable or the USB Connection Terminal.
- Close the cover of the USB Connection Terminal.

## Notes

- Change to a source other than the USB Memory mode, then remove the USB Memory. If the USB Memory is removed in the USB Memory mode, data may be damaged.
- When removing USB Memory, pull it out straight.
- If sound is not output or USB Memory is not recognized even when USB Memory is connected, remove USB Memory once, and then connection it again.
- Route the USB cable away from another cables, etc.
- After removing the USB Memory, close the cover of the USB Connection Terminal to prevent dust or foreign objects from entering and causing a malfunction.
- On how to connect an USB Memory to Rear USB Connector, refer to "Rear USB Memory Connection (sold separately)" on page 35.

## Using the USB Memory/Portable audio player Banking Function

When a USB Memory is connected, the follows description is available only when TAG is set in "Setting the USB Search Mode" (refer to "Setting the USB Search Mode" on page 23).

### What is a Bank?

A bank is a unit of up to 1,000 songs, which is stored in memory. "BANKING" refers to the grouping of songs available in USB Memory, in banks of 1,000 songs each. However, when a USB Memory is connected, 1BANK can store up to 1,000 songs under the following conditions. Otherwise, the number of songs that can be stored may be less than 1,000.

Conditions (general estimate values)

Playlists: 20 (32 characters; 64 bytes)  
Genres: 10 (32 characters; 64 bytes)  
Composers: 30 (32 characters; 64 bytes)  
Artists: 30 (32 characters; 64 bytes)  
Albums: 100 (32 characters; 64 bytes)  
Titles: 1,000 (32 characters; 64 bytes)  
Folders: 100 (32 characters; 64 bytes)  
Files: 1,000 (32 characters; 64 bytes)  
File Paths: 1,000 (128 characters; 256 bytes)

### About Banking

While a bank is being built up, "BANKING" is displayed. Banking occurs whenever a USB Memory device/Portable audio player is connected or after power to the head unit turns on.

It can take anywhere from a few seconds to up to several minutes for banking to complete. This depends on the number of files and folders in USB Memory/Portable audio player.

### Available operations while Banking

- During Banking, the information display changes so the VIEW operation is not available.
- With a song playing, Regular fast-forwarding and next song selection is available.
- While Banking, the song playback order may differ from the song order in the USB Memory device/Portable audio player.
- Searching is not recommended during the Banking process as the database is under construction at this time, and malfunction may result in some cases.

This unit has a BANK function that automatically divides every 1,000 songs stored in USB Memory/Portable audio player into individual banks to make searching and playing back a song easier. A maximum of 1,000 songs for one bank can be stored according to the order stored in USB Memory/Portable audio player. A maximum of 20 banks (20,000 songs) can be recognized.



Bank No.	Song number
Bank1	1~1,000
Bank2	1,001~2,000
⋮	⋮
Bank20	19,001~20,000

## Playback

### 1 Press SOURCE/ to select the USB mode.

Depending on which USB Connector you used, press **BAND/F/R** to switch USB source between FRONT and REAR.

### 2 Press or to select the desired track (file).

Pressing and holding  or  will fast backward/fast forward track continuously.

#### Note

- Depending on the connected portable audio player, fast-forwarding/fast-reversing may not be available.

### 3 To pause playback, press /II.

Pressing /II again will resume playback.

### Notes

- WMA format files that are protected by DRM (Digital Rights Management), AAC format files that have been purchased from the iTunes Store and files that are copy-protected (copyright protection) cannot be played back on this unit.
- The playback time may not be correctly displayed when a VBR (Variable Bit Rate) recorded file is played back.
- If there is tag information, artist name/album name/track name is displayed.
- If an MP3/WMA/AAC file contains ID3 tag/WMA tag information, the ID3 tag/WMA tag information is displayed (e.g., song name, artist name, and album name). All other tag data is ignored.
- "NO SUPPORT" is displayed when text information is not compatible with this unit.
- Before disconnecting USB Memory, be sure to change to another source or set to pause.
- Press **VIEW** to switch the display. For details, refer to "Displaying the Text" on page 18.

## Searching for a desired Song

You can select to search a song by Tag information or Explorer (FILE NAME) mode. Before you search a song, select your desired search mode in "Setting the USB Search Mode" (refer to "Setting the USB Search Mode" on page 23).

### Searching by Tag information

Before performing the following procedures, make sure TAG is selected in "Setting the USB Search Mode" (refer to "Setting the USB Search Mode" on page 23).

A Flash Memory Device or Portable audio player can contain hundreds of songs. By using file tag information and keeping these songs organized in playlists, this unit's search functions will ease song searches. Each music category has its own individual hierarchy. Use the Bank<sup>\*1</sup>/Playlists<sup>\*2</sup>/Artists/Albums/Songs/Genres/Composers/Folders/Files search mode to narrow searches based on the table below.

Hierarchy 1	Hierarchy 2	Hierarchy 3	Hierarchy 4	Hierarchy 5
Bank <sup>*1</sup>	Playlist <sup>*2</sup>	Song	—	—
Bank <sup>*1</sup>	Artist <sup>*</sup>	Album <sup>*</sup>	Song	—
Bank <sup>*1</sup>	Album <sup>*</sup>	Song	—	—
Bank <sup>*1</sup>	Song	—	—	—
Bank <sup>*1</sup>	Genre <sup>*</sup>	Artist <sup>*</sup>	Album <sup>*</sup>	Song
Bank <sup>*1</sup>	Composer <sup>*</sup>	Album <sup>*</sup>	Song	—
Bank <sup>*1</sup>	Folder	File	—	—



Hierarchy 1	Hierarchy 2	Hierarchy 3	Hierarchy 4	Hierarchy 5
Bank*1	File	—	—	—

\*1 A maximum of 1,000 songs for one bank can be stored according to the order stored in Flash Memory/Portable audio player. However, song stored order in bank may differ from the song order in the Flash Memory device/Portable audio player in some case.

\*2 Playlist search is not available when a Portable audio player is connected.

#### For example:

Searching by Artist name

The following example explains how an Artists search is performed. Another search mode can be used for the same operation, although the hierarchy differs.



## Searching by artist name

- 1 Press **Q** /ENTER to activate the search selection mode.
- 2 Turn the **Rotary encoder** to select a desired Bank, and then press **Q** /ENTER.  
"BANKING" may be displayed for a few seconds.
- 3 Turn the **Rotary encoder** to select the Artist search mode, and then press **Q** /ENTER.  
PLAYLIST ↔ ARTIST ↔ ALBUM ↔ SONG ↔ GENRE ↔ COMPOSER  
↔ FOLDER ↔ FILE ↔ PLAYLIST
- 4 Turn the **Rotary encoder** to select the desired Artist, and then press **Q** /ENTER.
- 5 Turn the **Rotary encoder** to select an album, and then press **Q** /ENTER.
- 6 Turn the **Rotary encoder** to select a song and press **Q** /ENTER.  
The selected song is played back.

## Searching by Explorer (FILE NAME) mode (Flash Memory only)

Before performing the following procedures, make sure FILE NAME is selected in "Setting the USB Search Mode" (refer to "Setting the USB Search Mode" on page 23).

Flash Memory can contain hundreds of songs. By organizing songs by folder, you can quickly find a desired folder/file. This operation is similar to search a folder/file from PC.



- 1 Press **Q** /ENTER to activate the search mode.
- 2 Turn the **Rotary encoder** to select a desired folder/file.  
When a folder is searched,  indicator lights up.  
When a file is searched,  indicator lights up.
- 3 Press **Q** /ENTER to play the selected file or enter the selected folder.  
Press and hold **Q** /ENTER for at least 2 seconds to play back all songs in the selected folder.
- 4 Repeat steps 2 to 3 until the desired folder/file is found when a folder is entered in step 3.

#### Notes

- When a portable audio player is connected, even though FILE NAME is set in "Setting the USB Search Mode" (refer to "Setting the USB Search Mode" on page 23), the Tag information search mode will be applied.

- In the Tag search mode, after pressing and holding **Q** /ENTER for at least 2 seconds while in each hierarchy (except Song and File hierarchy), all songs of the selected hierarchy are played back.
- Even if the songs belong to the same playlist, they may be saved as different BANK.
- After selecting [ALL] in the Tag search mode with **⌘**, press and hold **Q** /ENTER for at least 2 seconds to play back all songs in the selected search mode.
- While in the search mode, if you press and hold **↶** for at least 2 seconds, or no operation is performed for 60 seconds, the search mode is cancelled.
- The root folder of Flash Memory/Portable audio player is displayed as "\ROOT".
- When the bank is changed during Repeat play, the Repeat play will be cancelled.
- In the search mode, pressing **↶** will return to the previous mode.
- When search is made during M.I.X. play, the M.I.X. play mode will be cancelled.
- If any one of the **preset buttons (1 through 6)** is pressed in the search mode, a search can be made quickly by skipping to the specified location. For details, refer to "Direct Search Function" on page 28.
- In the Tag search mode, a search can be made quickly by Alphabet skip function to find the desired artist or song, etc. For details, refer to "Alphabet Skip Function (Tag search mode only)" on page 26.
- In the Explorer (FILE NAME) search mode, a search can be made quickly by USB Skip function to find the desired folder/file. For details, refer to "Setting the USB Skip function" on page 23.
- When searching for a song, artist, etc., in Flash Memory, the display order may be incorrect if the character code of the file tag information is mixed.

## Repeat Play

- 1 Press **↶** 4.  
The song is played back repeatedly.  
When a song is searched by Tag information  
**↶**\*1 → **↶** \*2 → **↶** \*3 → (off) → **↶**  
When a folder/file is searched by Explorer (FILE NAME) mode (Flash Memory only)  
**↶**\*1 → **↶** \*4 → (off) → **↶**  
\*1 Only a file is repeatedly played back.  
\*2 According to the artist information of the current song, a playlist about all the songs with the same artist of the Bank are made into a playlist, which then starts to play back.  
\*3 According to the album information of the current song, a playlist about all the songs with the same album of the Bank are made into a playlist, which then starts to play back.  
\*4 Only files in a folder are repeatedly played back.
- 2 To cancel repeat play, select (off) with the above procedure.  
**Note**
  - During repeat play, setting M.I.X. to ON will cancel the repeat play.

---



## M.I.X. (Random Play)

---

### 1 Press 5 .

The songs are played back in random sequence.

**When a song is searched by Tag information**

 \*1 →  ALL\*2 → (off) →  

**When a folder/file is searched by Explorer (FILE NAME) mode (Flash Memory only)**

 \*3 →  ALL\*4 → (off) →  

- \*1 Song shuffle randomly plays back songs within a selected category (playlist, album, etc.). The songs within the category are played just once until all songs have been played.
- \*2 All songs in the current Bank are played back in random sequence. Any one song does not play back again until all songs have been played back.
- \*3 All songs in the current folder are played back in random sequence. Any one song does not play back again until all songs have been played back.
- \*4 All songs in the Flash Memory are played back in random sequence. Any one song does not play back again until all songs have been played back.

### 2 To cancel M.I.X. play, select (off) with the above procedure.

#### Notes

- When a song is played back during Random (M.I.X.) play in the USB mode, the song can be played back again randomly even if not all songs in the current Bank or Flash Memory have been played back.
- During M.I.X. play, setting repeat play to ON will cancel the M.I.X. play.
- During repeat play, etc., the track number display for M.I.X. play may be incorrect.

---

## Select Playlist/Artist/Album/Genre/Composer/Folder

---

Playlist\*/Artist/Album/Genre/Composer/Folder can be easily changed. For example, if you listen to a song from a selected album, the album can be changed.

**Press ▲ or ▼ to select the desired Playlist\*/Artist/Album/Genre/Composer/Folder.**

\* This item is invalid when a portable audio player is connected.

#### Notes

- If the song search mode was used to select a song, this function is inactive.
- If an album is selected during an artist search, other albums by that artist are searchable.
- For Flash Memory, this function is inactive during M.I.X. ALL/M.I.X. song playback.
- For Portable audio player, this function is inactive during M.I.X. playback.
- This function is inactive during RPT ALBUM/RPT ARTIST playback.

---

## Alphabet Skip Function (Tag search mode only)

---

The initial skip function is skipped to the next number, symbol or letter such as from A to B, B to C.

You can skip in reverse order such as B to A by pressing ▲.

**During Tag search mode, press ▲ or ▼ to perform the Alphabet Skip Function.**

A list is skipped to the next number, symbol or letter.

#### Notes

- Characters defined for skipping are from the UTF-16 standard common in many computer systems.
- If the Song search mode is activated in Playlist search, this function is invalid.

---

## Quick Search

---

You can search for a song from all songs in current bank of Flash Memory/Portable audio player without selecting an album, artist, etc.

### 1 Press and hold /ENTER for at least 2 seconds to activate Quick Search mode.

### 2 Turn the Rotary encoder to select a desired track (file). The selected track is played back immediately.

#### Note

- Press  in the search mode to cancel. Or, the search mode is cancelled if no operation is performed for 10 seconds.

---

## Search Position Memory

---

During playback, you can quickly return to the last-selected hierarchy level in the search mode.

**Press .**

The hierarchy you selected last in the search mode is displayed.

# iPod/iPhone (optional)

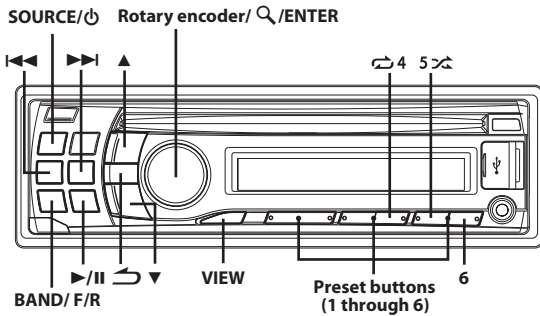

## Connecting an iPod/iPhone

An iPod/iPhone can be connected to this unit by using the Interface cable for iPod (sold separately). When an iPod/iPhone is connected to this unit, you can choose to control the iPod/iPhone using its own controls or by the head unit controls. For details, refer to “Setting the iPod Control” on page 27.

The Owner’s Manual only introduces on how to control an iPod/iPhone via this unit. So before the following operation, make sure to set HU (HEAD UNIT) in “Setting the iPod Control” (refer to “Setting the iPod Control” on page 27). On how to control an iPod/iPhone on itself, refer to Owner’s Manual of iPod/iPhone.

### Notes

- Internet and telephone functions of the iPod touch or iPhone, ect., can also be used while connected to this unit. Using these functions will stop or pause the currently playing songs. During this time, do not operate the unit to avoid a malfunction.
- If you connect an iPhone to this unit, it can be used as an iPod. If you use iPhone as a hands-free phone, you need the optional BLUETOOTH INTERFACE.
- There are two USB connectors on this unit, you can choose to connect an iPod/iPhone to Front USB Connection Terminal or Rear USB Connector. On how to connect an iPod/iPhone to this unit, refer to “iPod/iPhone Connection (sold separately)” on page 34.
- Do not leave an iPod/iPhone in a car, as its mechanism is sensitive to high temperature and humidity conditions, and damage may result.

### About iPod/iPhone models usable with this unit

- Confirmed devices regarding Made for iPod. Correct function of earlier versions cannot be guaranteed.
  - iPod touch (4th generation): Ver.4.2.1
  - iPod nano (6th generation): Ver.1.0
  - iPod touch (3rd generation): Ver.4.2.1
  - iPod nano (5th generation): Ver.1.0.2 PC
  - iPod classic (160 GB) (Late 2009): Ver.2.0.4
  - iPod touch (2nd generation): Ver.4.2.1
  - iPod nano (4th generation): Ver.1.0.4
  - iPod classic (120 GB): Ver.2.0.1
  - iPod touch (1st generation): Ver.3.1.3
  - iPod nano (3rd generation): Ver.1.1.3 PC
  - iPod classic (80 GB, 160 GB): Ver.1.1.2
  - iPod nano (2nd generation): Ver.1.1.3
  - iPod with video: Ver.1.3
  - iPod nano (1st generation): Ver.1.3.1
- Confirmed devices regarding Made for iPhone. Correct function of earlier versions cannot be guaranteed.
  - iPhone 4: Ver.4.2.1
  - iPhone 3GS: Ver.4.2.1

iPhone 3G: Ver.4.2.1

iPhone: Ver.3.1.3

- For clarity in identifying your model of iPod, please see Apple’s own document “Identifying iPod models” at <http://support.apple.com/kb/HT1353>
- This unit does not support video playback from iPod/iPhone, even using a video-compatible cable.

## Setting the iPod Control

When an iPod/iPhone is connected, operate it from its own controls or from the head unit.

**Press and hold  $\mathcal{Q}$ /ENTER for at least 2 seconds to switch iPod control mode between HU (HEAD UNIT) and iPod.**

Once the control mode is changed, this will set pause status, press  $\blacktriangleright$ /II to continue.

### HU (HEAD UNIT):

Operate the iPod/iPhone via this unit.

### iPod:

Operate the iPod/iPhone using its own controls. When iPod is selected, some functions will not be operable via the head unit.

## Playback

- Press SOURCE/⏻ to switch to the iPod mode.**  
Depending on which USB Connector you used, press BAND/F/R to switch iPod source between FRONT and REAR.
- Press  $\blacktriangleleft$  or  $\blacktriangleright$  to select the desired song.**  
Pressing and holding  $\blacktriangleleft$  or  $\blacktriangleright$  will fast backward/fast forward the current track.
- To pause playback, press  $\blacktriangleright$ /II.**  
Pressing  $\blacktriangleright$ /II again will resume playback.

### Notes

- A song playing on the iPod/iPhone while it is connected to this unit will continue to play from where it was paused after disconnection.
- If you listen to an episode from a selected Podcast or Audiobook, the episode can be changed by pressing  $\blacktriangle$  or  $\blacktriangledown$ .
- An episode may have several chapters. The chapter can be changed by pressing  $\blacktriangleleft$  or  $\blacktriangleright$ .

## Searching for a desired Song

An iPod/iPhone can contain hundreds of songs. By using file tag information and keeping these songs organised in playlists, this unit’s search functions will ease song searches.

Each music category has its own individual hierarchy. Use the Playlist/Artist/Album/Song/Podcast/Genre/Composer/Audiobook search mode to narrow searches based on the table below.

Hierarchy 1	Hierarchy 2	Hierarchy 3	Hierarchy 4
Playlist	Song	—	—
Artist*	Album*	Song	—
Album*	Song	—	—
Song	—	—	—
Podcast	Episode	—	—
Genre*	Artist*	Album*	Song
Composer*	Album*	Song	—

Hierarchy 1	Hierarchy 2	Hierarchy 3	Hierarchy 4
Audiobook	—	—	—

#### For example:

Searching by Artist name

The following example explains how an ARTIST search is performed.

Another search mode can be used for the same operation, although the hierarchy differs.

- 1 Press **Q** / **ENTER** to activate the search selection mode. The “**Q**” indicator lights up.
- 2 Turn the **Rotary encoder** to select the **ARTIST** search mode, and then press **Q** / **ENTER**.  
PLAYLIST ↔ ARTIST ↔ ALBUM ↔ SONG ↔ PODCAST ↔ GENRE  
↔ COMPOSER ↔ AUDIOBOOK ↔ PLAYLIST
- 3 Turn the **Rotary encoder** to select the desired Artist, and then press **Q** / **ENTER**.
- 4 Turn the **Rotary encoder** to select the desired Album, and then press **Q** / **ENTER**.
- 5 Turn the **Rotary encoder** to select the desired Song, and then press **Q** / **ENTER**.

#### Notes

- This function is unavailable when iPod is selected in “Setting the iPod Control” (refer to “Setting the iPod Control” on page 27).
- After pressing and holding **Q** / **ENTER** for at least 2 seconds while in each hierarchy (except SONG and AUDIOBOOK hierarchy), all songs of the selected hierarchy are played back.
- After selecting [ALL] in the search mode with<sup>α\*</sup>, press and hold **Q** / **ENTER** for at least 2 seconds to play back all songs in the iPod/iPhone or selected search mode.
- While in the search mode, if you press and hold **↶** for 2 seconds, or no operation is performed for 60 seconds, the search mode is cancelled.
- In the search mode, pressing **↶** will return to the previous mode.
- When search is made during M.I.X. play, the M.I.X. play mode will be cancelled.
- “NO SONG” will be displayed if there are no songs in the selected playlist in the PLAYLIST search mode.
- “NO PODCAST” will be displayed if there is no podcast data in the iPod/iPhone in the PODCAST search mode.
- “NOAUDIOBOOK” will be displayed if there is no audiobook data in the iPod/iPhone in AUDIOBOOK search mode.
- If “iPod name” stored in the iPod/iPhone is selected in the desired Playlist search mode, and **Q** / **ENTER** is pressed, you can search for all songs in the iPod/iPhone. Also, if you press and hold **Q** / **ENTER** for at least 2 seconds, all songs in the iPod/iPhone are played back.
- Depending on the iPod/iPhone, podcast search is not supported.
- If any one of the **preset buttons (1 through 6)** is pressed in the search mode, a search can be made quickly by skipping to the specified location. For details, refer to “Direct Search Function” on page 28.

## Direct Search Function

The unit’s direct search function can be used to search for an album, song, etc., more efficiently. In PLAYLIST/ARTIST/ALBUM/SONG/PODCAST/GENRE/COMPOSER/AUDIOBOOK mode, you can quickly target any song.

**In the search mode, press any one of the preset buttons (1 through 6) to quickly skip over a designated percent of your song content.**

#### Song search example:

If there are 100 songs in your iPod/iPhone, they are divided into 6 groups using percentages (shown below). These groups are assigned to the preset buttons (1 through 6).

#### Example 1:

Suppose the song you are searching for is located at around the middle (50%) of your library: press button 4 to jump to the 50th song and turn the **Rotary encoder** to find the desired song.

#### Example 2:

Suppose the song you are searching for is located near the end (83%) of your library: press button 6 to jump to the 83rd song and turn the **Rotary encoder** to find the desired song.

	All 100 songs (100%)					
	0%	17%	33%	50%	67%	83%
Preset buttons	1	2	3	4	5	6
Songs	1st song	17th song	33rd song	50th song	67th song	83rd song

## Select Playlist/Artist/Album/Genre/Composer/Episode

Playlist/Artist/Album/Genre/Composer/Episode can be easily changed. For example, if you listen to a song from a selected album, the album can be changed.

**Press ▲ or ▼ to select the desired Playlist/Artist/Album/Genre/Composer/Episode.**

#### Notes

- If the song search mode was used to select a song, this function is inactive.
- If an album is selected during an artist search, other albums by that artist are searchable.
- This function is inactive during shuffle (M.I.X.) playback.

## Alphabet Skip Function

The initial skip function is skipped to the next number, symbol or letter such as from A to B, B to C.

You can skip in reverse order such as B to A by pressing ▲.

**During search mode, press ▲ or ▼ to perform the Alphabet Skip Function.**

A list is skipped to the next number, symbol or letter.

---

## Search Position Memory

---

During iPod/iPhone playback, you can quickly return to the last-selected hierarchy level in the search mode.

Press .

The hierarchy you selected last in the search mode is displayed.

### Note

- This function is unavailable when iPod is selected in “Setting the iPod Control” (refer to “Setting the iPod Control” on page 27).

---

## Random Play Shuffle (M.I.X.)

---

The Shuffle function of the iPod/iPhone is displayed as  on this unit.

### Shuffle Albums:







The songs on each album are played back in proper order. Upon completion of all the songs on the album, the next album is selected randomly. This continues until all albums have been played.

### Shuffle Songs:

Song shuffle randomly plays back songs within a selected category (playlist, album, etc.). The songs within the category are played just once until all songs have been played.

1 Press 5 .

The songs are played back in random sequence.

 \*1 →  \*2 → (off) →  

\*1 Shuffle Albums.

\*2 Shuffle Songs.

2 To cancel M.I.X. play, select (off) with the above procedure.

### Note



- If a song is selected in the album search mode before selecting M.I.X. play, the songs will not play back randomly even when Shuffle Albums is selected.

### Shuffle ALL:

Shuffle ALL plays all songs in the iPod/iPhone randomly. Any one song does not play back again until all songs have been played back.

1 Press 6.

The songs are played back in random sequence.

 ALL → (off) →  ALL

\* Shuffle ALL.

2 To cancel M.I.X. play, select (off) with the above procedure.

### Notes

- If Shuffle ALL is selected, the selected songs being played back in the search mode are cancelled.
- This function is unavailable when iPod is selected in “Setting the iPod Control” (refer to “Setting the iPod Control” on page 27).

---

## Repeat Play

---



Only Repeat One is available for the iPod/iPhone.

### Repeat One:

A single song is repeatedly played back.

1 Press  4.

The song is played back repeatedly.

\* → (off) → 

\* Repeat One.

2 To cancel repeat play, select (off) with the above procedure.

### Note

- Depending on the connected iPod, track up/down may be not available during Repeat play.

---

## Displaying the Text

---

You can display the tag information of a song in the iPod/iPhone.

### Press VIEW.

Each press changes the display.

### Note

- When the TEXT SCR is set to SCR MANUAL, press and hold  for at least 2 seconds, the current text will be scrolled one time.

TRACK NO./ELAPSED TIME → ARTIST NAME\* → ALBUM NAME\* → SONG TITLE\* → TRACK NO./ELAPSED TIME

\* TAG information

“ARTIST”/“ALBUM”/“SONG” is displayed if there is no tag information.

### Notes

- Only alphanumeric characters (ASCII) can be displayed.
- The maximum number of characters for the head unit is 128 (128 byte).
- Some characters may not be correctly displayed.
- “NO SUPPORT” is displayed if text information is not supported by the unit.

# Information

## In Case of Difficulty

If you encounter a problem, please turn the power off, then on again. If the unit is still not functioning normally, please review the items in the following checklist. This guide will help you isolate the problem if the unit is at fault. Otherwise, make sure the rest of your system is properly connected or consult your authorized Alpine dealer.

### Basic

#### No function or display.

- Vehicle's ignition is off.
  - If connected following instructions, the unit will not operate with the vehicle's ignition off.
- Improper power lead (Red) and battery lead (Yellow) connections.
  - Check power lead and battery lead connections.
- Blown fuse.
  - Check the fuse of the unit; replace with the proper value if necessary.
- Internal micro-computer malfunctioned due to interference noise etc.
  - Press the RESET switch with a ballpoint pen or other pointed article.

### Radio

#### Unable to receive stations.

- No antenna or open connection in cable.
  - Make sure the antenna is properly connected; replace the antenna or cable if necessary.

#### Unable to tune stations in the seek mode.

- You are in a weak signal area.
  - Make sure the tuner is in the DX mode.
- If the area you are in is a primary signal area, the antenna may not be grounded and connected properly.
  - Check your antenna connections; make sure the antenna is properly grounded at its mounting location.
- The antenna may not be the proper length.
  - Make sure the antenna is fully extended; if broken, replace the antenna with a new one.

#### Broadcast is noisy.

- The antenna is not the proper length.
  - Extend the antenna fully; replace it if it is broken.
- The antenna is poorly grounded.
  - Make sure the antenna is grounded properly at its mounting location.

### CD

#### CD Player not functioning.

- Out of operating temperature range +50°C (+120°F) for CD.
  - Allow the vehicle's interior (or trunk) temperature to cool.

#### CD playback sound is wavering.

- Moisture condensation in the CD Module.
  - Allow enough time for the condensation to evaporate (about 1 hour).

#### CD insertion not possible.

- A CD is already in the CD player.
  - Eject the CD and remove it.

- The CD is being improperly inserted.
  - Make sure the CD is being inserted following instructions in the CD Player Operation section.

#### Unable to fast forward or backward the CD.

- The CD has been damaged.
  - Eject the CD and discard it; using a damaged CD in your unit can cause damage to the mechanism.

#### CD playback sound skips due to vibration.

- Improper mounting of the unit.
  - Securely re-mount the unit.
- The disc is very dirty.
  - Clean the disc.
- The disc has scratches.
  - Change the disc.
- The pick-up lens is dirty.
  - Do not use a commercially available lens cleaner disc. Consult your nearest Alpine dealer.

#### CD playback sound skips without vibration.

- The disc is dirty or scratched.
  - Clean the disc; damaged disc should be replaced.

#### Error displays (built-in CD player only).

- Mechanical error
  - Press . After the error indication disappears, insert the disc again. If the above-mentioned solution does not solve the problem, consult your nearest Alpine dealer.

#### CD-R/CD-RW playback not possible.

- Close session (finalisation) has not been performed.
  - Perform finalisation and attempt playback again.

### MP3/WMA/AAC

#### MP3, WMA or AAC is not played back.

- Writing error occurred. The MP3/WMA/AAC format is not compatible.
  - Make sure the MP3/WMA/AAC has been written in a supported format. Refer to "About MP3/WMA/AAC" on page 14, then rewrite in the format supported by this device.

### Audio

#### The sound is not output from the speakers.

- Unit has no output signal of the internal amplifier.
  - POWER IC is switched to "ON", refer to "Connecting to an External Amplifier (POWER IC)" on page 22.

### iPod

#### iPod does not play and no sound is output.

- The iPod has not been recognised.
  - Reset this unit and the iPod. Refer to "Initial System Start-Up" on page 8. To reset the iPod, refer to the Owner's Manual of the iPod.

### Indication for CD Player

#### NO DISC

- No CD is inserted.
  - Insert a CD.
- Although a disc is inserted, "NO DISC" is displayed and the unit does not start to play or eject the disc.
  - Remove the disc by following these steps:
    - Press the  button again for at least 2 seconds.
  - If the disc still does not eject, consult your Alpine dealer.

## ERROR

- Mechanism error.
  - 1 Press the **▲** button and eject the CD.  
If not ejecting, consult your Alpine dealer.
  - 2 When the error indication remains after ejecting, press the **▲** button again.  
If the error indication still does not turn off after pressing the **▲** button for a few times, consult your Alpine dealer.
- When "ERROR" is displayed:  
If the disc cannot be ejected by pressing **▲**, press the **RESET** switch (Refer to "Initial System Start-Up" on page 8) and press **▲** again.  
If the disc still cannot be ejected, consult your Alpine dealer.

## PROTECT

- A copy-protected WMA file was played back.
  - You can only play back non-copy-protected files.

## UNSUPPORTED

- A sampling rate/bit rate not supported by the unit is used.
  - Use a sampling rate/bit rate that is supported by the unit.

## Indication for USB Memory/Portable audio player

### ERROR-01

- Database error or decoder error.
  - You can solve the problem by switching the source.

### ERROR-02

- Communication error or boot error, etc.
  - You can solve the problem by reconnecting the Flash Memory/Portable audio player or changing source.

### ERROR-04

- Abnormal current is run to the USB connector device.
  - You can solve the problem by switching the source.

### NO SONG

or

### NO FILE

- No song (file) is stored in the Flash Memory/Portable audio player.
  - Connect the Flash Memory device/Portable audio player after storing songs (files).

## UNSUPPORTED

- A sampling rate/bit rate not supported by the unit is used.
  - Use a sampling rate/bit rate that is supported by the unit.

## PROTECT

- A copy-protected WMA file was played back.
  - You can only play back non-copy-protected files.

## NO SUPPORT

- Text information that is not recognizable by the unit has been input.
  - Use a USB Memory device with input text information that is supported by the unit.

## Indication for iPod Mode

### NO SONG

- There are no songs in the iPod/iPhone.
  - Download songs to the iPod/iPhone and connect to this unit.

### ERROR-01

- Database error or decoder error.
  - You can solve the problem by switching the source.

### ERROR-02

- Communication error or boot error, etc.
  - You can solve the problem by reconnecting the iPod/iPhone or changing source.

### ERROR-03

- The iPod/iPhone is not verified.
  - You can solve the problem by reconnecting the iPod/iPhone.

### ERROR-04

- Abnormal current is run to the USB connector device.
  - You can solve the problem by switching the source.

## Specifications

### FM TUNER SECTION

Tuning Range	87.5~108.0 MHz
Mono Usable Sensitivity	0.7 $\mu$ V
Alternate Channel Selectivity	80 dB
Signal-to-Noise Ratio	65 dB
Stereo Separation	35 dB
Capture Ratio	2.0 dB

### MW TUNER SECTION

Tuning Range	531~1,602 kHz
Sensitivity (IEC Standard)	25.1 $\mu$ V/28 dB

### LW TUNER SECTION

Tuning Range	153~281 kHz
Sensitivity (IEC Standard)	31.6 $\mu$ V/30 dB

### CD PLAYER SECTION

Frequency Response	5~20,000 Hz ( $\pm$ 1 dB)
Wow & Flutter (% WRMS)	Below measurable limits
Total Harmonic Distortion	0.008% (at 1 kHz)
Dynamic Range	95 dB (at 1 kHz)
Signal-to-Noise Ratio	105 dB
Channel Separation	85 dB (at 1 kHz)

### USB SECTION

USB requirements	USB 1.1/2.0
Max. Power Consumption	500 mA
USB Class	Mass Storage
File System	FAT 12/16/32
MP3 Decoding	MPEG-1/2 AUDIO Layer-3
WMA Decoding	Windows Media™ Audio
AAC Decoding	AAC-LC format “.m4a” file
Number of Channels	2-Channel (Stereo)
Frequency Response*	5~20,000 Hz ( $\pm$ 1 dB)
Total Harmonic Distortion	0.008% (at 1 kHz)
Dynamic Range	95 dB (at 1 kHz)
Signal-to-Noise Ratio	105 dB
Channel Separation	85 dB (at 1 kHz)

\* Frequency response may differ depending on the encoder software/bit rate.

### PICKUP

Wave length	795 nm
Laser power	CLASS I

### GENERAL

Power Requirement	14.4 V DC (11~16 V allowable)
Maximum Power Output	50 W $\times$ 4
Maximum Pre-Output Voltage	2 V/10 k ohms
Bass	$\pm$ 14 dB at 60 Hz
Mid	$\pm$ 14 dB at 1 kHz
Treble	$\pm$ 14 dB at 10 kHz
Weight	1.6 kg (3 lbs. 8 oz)

### CHASSIS SIZE

Width	178 mm (7")
Height	50 mm (2")

Depth	161 mm (6~3/8")
-------	-----------------

### NOSEPIECE SIZE

Width	170 mm (6~3/4")
Height	46 mm (1~13/16")
Depth	25 mm (1")

### Note

- Due to continuous product improvement, specifications and design are subject to change without notice.

### CAUTION



(Bottom side of player)



---

---

# Installation and Connections

Before installing or connecting the unit, please read the following and refer to "Operating Instructions" on page 5 for proper use.

## WARNING

---

### MAKE THE CORRECT CONNECTIONS.

Failure to make the proper connections may result in fire or product damage.

---

### USE ONLY IN CARS WITH A 12 VOLT NEGATIVE GROUND.

(Check with your dealer if you are not sure.) Failure to do so may result in fire, etc.

---

### BEFORE WIRING, DISCONNECT THE CABLE FROM THE NEGATIVE BATTERY TERMINAL.

Failure to do so may result in electric shock or injury due to electrical shorts.

---

### DO NOT SPLICE INTO ELECTRICAL CABLES.

Never cut away cable insulation to supply power to other equipment. Doing so will exceed the current carrying capacity of the wire and result in fire or electric shock.

---

### DO NOT DAMAGE PIPE OR WIRING WHEN DRILLING HOLES.

When drilling holes in the chassis for installation, take precautions so as not to contact, damage or obstruct pipes, fuel lines, tanks or electrical wiring. Failure to take such precautions may result in fire.

---

### DO NOT USE BOLTS OR NUTS IN THE BRAKE OR STEERING SYSTEMS TO MAKE GROUND CONNECTIONS.

Bolts or nuts used for the brake or steering systems (or any other safety-related system), or tanks should NEVER be used for installations or ground connections. Using such parts could disable control of the vehicle and cause fire etc.

---

### KEEP SMALL OBJECTS SUCH AS BATTERIES OUT OF THE REACH OF CHILDREN.

Swallowing them may result in serious injury. If swallowed, consult a physician immediately.

---

### DO NOT INSTALL IN LOCATIONS WHICH MIGHT HINDER VEHICLE OPERATION, SUCH AS THE STEERING WHEEL OR SHIFT LEVER.

Doing so may obstruct forward vision or hamper movement etc. and results in serious accident.

---

## CAUTION

---

### HAVE THE WIRING AND INSTALLATION DONE BY EXPERTS.

The wiring and installation of this unit requires special technical skill and experience. To ensure safety, always contact the dealer where you purchased this product to have the work done.

---

### USE SPECIFIED ACCESSORY PARTS AND INSTALL THEM SECURELY.

Be sure to use only the specified accessory parts. Use of other than designated parts may damage this unit internally or may not securely install the unit in place. This may cause parts to become loose resulting in hazards or product failure.

---

### ARRANGE THE WIRING SO IT IS NOT CRIMPED OR PINCHED BY A SHARP METAL EDGE.

Route the cables and wiring away from moving parts (like the seat rails) or sharp or pointed edges. This will prevent crimping and damage to the wiring. If wiring passes through a hole in metal, use a rubber grommet to prevent the wire's insulation from being cut by the metal edge of the hole.

---

### DO NOT INSTALL IN LOCATIONS WITH HIGH MOISTURE OR DUST.

Avoid installing the unit in locations with high incidence of moisture or dust. Moisture or dust that penetrates into this unit may result in product failure.

---

## PRECAUTIONS

- Be sure to disconnect the cable from the (-) battery post before installing your CDE-123R. This will reduce any chance of damage to the unit in case of a short-circuit.
- Be sure to connect the colour coded leads according to the diagram. Incorrect connections may cause the unit to malfunction or damage to the vehicle's electrical system.
- When making connections to the vehicle's electrical system, be aware of the factory installed components (e.g. on-board computer). Do not tap into these leads to provide power for this unit. When connecting the CDE-123R to the fuse box, make sure the fuse for the intended circuit of the CDE-123R has the appropriate amperage. Failure to do so may result in damage to the unit and/or the vehicle. When in doubt, consult your Alpine dealer.
- The CDE-123R uses female RCA-type jacks for connection to other units (e.g. amplifier) having RCA connectors. You may need an adaptor to connect other units. If so, please contact your authorized Alpine dealer for assistance.
- Be sure to connect the speaker (-) leads to the speaker (-) terminal. Never connect left and right channel speaker cables to each other or to the vehicle body.

---

### IMPORTANT

Please record the serial number of your unit in the space provided below and keep it as a permanent record. The serial number or the engraved serial number is located on the bottom of the unit.

SERIAL NUMBER: [	]
INSTALLATION DATE: [	]
INSTALLATION TECHNICIAN: [	]
PLACE OF PURCHASE: [	]

## Installation

### CAUTION

When you install this unit in your car, do not remove the detachable front panel. If the detachable front panel is removed during installation, you might press too hard and warp the metal plate that holds it in place. The main unit must be mounted within 35 degrees of the horizontal plane, back to front.

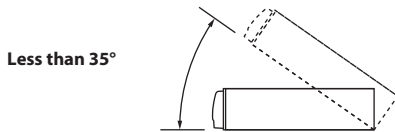

- 1 Remove the mounting sleeve from the main unit (Refer to "Removal" on page 34). Slide the mounting sleeve into the dashboard and fix it with the metal shackles.

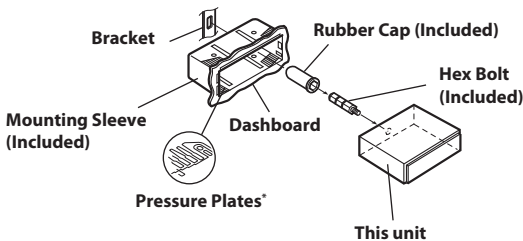

\* If the installed mounting sleeve is loose in the dashboard, the pressure plates may be bent slightly to remedy the problem.

- 2 When your vehicle has the Bracket, mount the long hex bolt onto the rear panel of the CDE-123R and put the Rubber Cap on the hex bolt. If your vehicle does not have the Mounting Support, reinforce the head unit with the metal mounting strap (not supplied). Connect all the leads of the CDE-123R according to details described in the CONNECTIONS section.

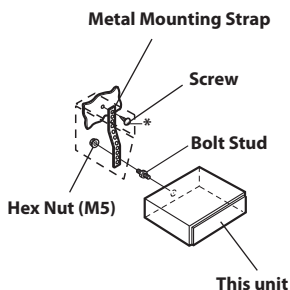

\* For the screw\*, provide a proper screw to the chassis installing location.

- 3 Slide the CDE-123R into the dashboard. When the unit is in place, make sure the locking pins are fully seated in the down position. This can be done by pressing firmly in on the unit while pushing the locking pin down with a small screwdriver. This ensures that the unit is properly locked and will not accidentally come out from the dashboard. Install the detachable front panel.

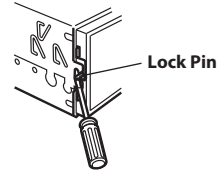

## Removal

- 1 Remove the detachable front panel.
- 2 Use a small screwdriver (or similar tool) to push the locking pins to the "up" position (see above drawing). As each pin is unlocked, gently pull out on the unit to make sure it does not re-lock before unlocking the second pin.
- 3 Pull the unit out, keeping it unlocked as you do so.

JAPANESE CAR

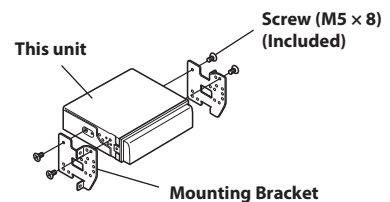
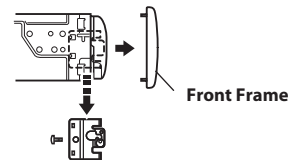

## iPod/iPhone Connection (sold separately)

- 1 Connect USB cable to an iPod/iPhone with Interface cable for iPod.

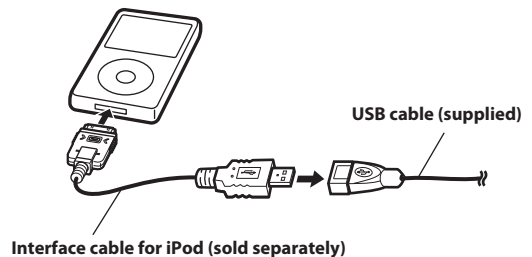

- 2 Connect the USB cable to the USB connector of this unit.

## When connect to Front USB Connection Terminal

- 1 Open the cover of the USB Connection Terminal.
- 2 Connect the Interface cable for iPod directly to the USB Connection Terminal, or via the USB cable.

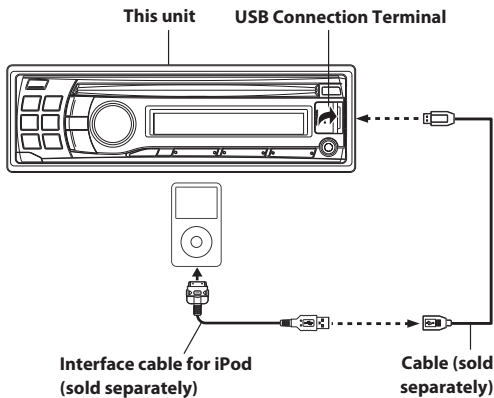

## When connect to Rear USB Connector

Connect the USB cable to the Rear USB connector of the unit, and then secure the connection using the lock case supplied with USB cable as shown below.

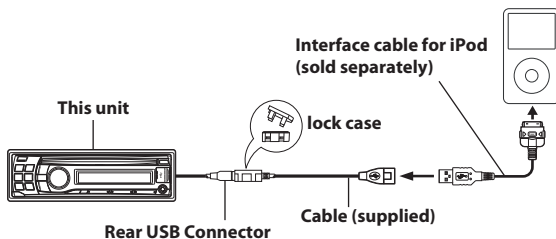

## Remove the iPod/iPhone

Remove the iPod/iPhone from Interface cable for iPod.

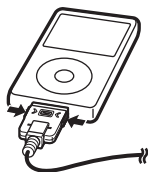

### Notes

- This unit can charge the iPod/iPhone of the current source, and it may stop charging when another source is switched.
- After changing the unit to a source other than the USB iPod, remove the iPod/iPhone. If the iPod/iPhone is removed in the USB iPod mode, data may cause damage.
- If sound is not output or the iPod/iPhone is not recognised even when the iPod/iPhone is connected, remove the iPod/iPhone once, then connect it again, or reset the iPod.
- Do not leave the iPod/iPhone in a vehicle for a long time. Heat and humidity may damage the iPod/iPhone and you may not be able to play it again.

## Rear USB Memory Connection (sold separately)

### Connect USB Memory

Connect the USB cable to the Rear USB connector of the unit, and then secure the connection using the lock case supplied with USB cable as shown below.

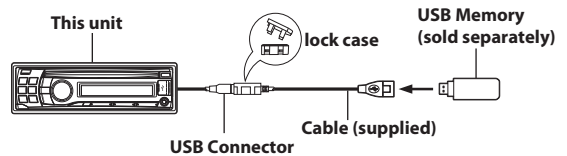

### Remove USB Memory

Pull out USB Memory squarely from the USB cable.

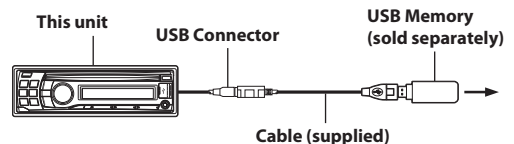

### Notes

- When removing USB Memory, pull it out straight.
- If sound is not output or USB Memory is not recognized even when USB Memory is connected, remove USB Memory once, then connect it again.
- Change to a source other than the USB Memory mode, then remove the USB Memory. If the USB Memory is removed in the USB Memory mode, data may be damaged.
- Route the USB cable away from another cables.

# Connections

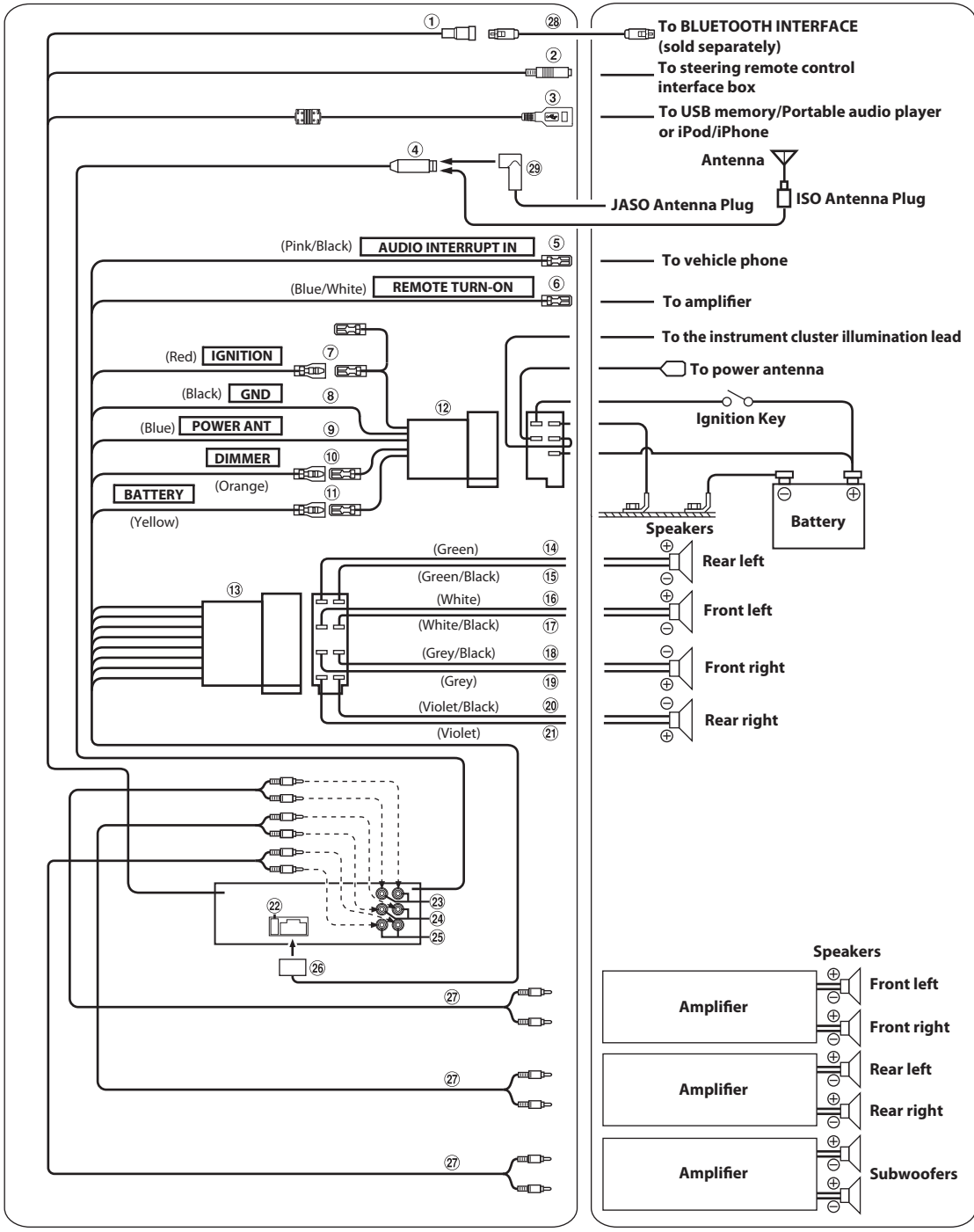

- ① **BLUETOOTH interface Connector**  
Connect this to an optional BLUETOOTH INTERFACE. To use a hands-free mobile phone, an optional BLUETOOTH INTERFACE connection is required. For details on connection, refer to the Owner's Manual of the BLUETOOTH INTERFACE.  
You can also connect this to an external device (such as a portable player) by using Conversion cable (KCE-237B) for building up the AUX IN (sold separately).
- Note**
- Refer to "Setting the AUX REAR Setup Mode (AUX-R SET)" on page 21.
- AUX-R ON :**  
When the external device is connected.
- AUX-R OFF :**  
When set to OFF, AUX REAR source cannot be selected.
- ② **Steering Remote Control Interface Connector**  
To steering remote control interface box. For details, contact your Alpine dealer.
- ③ **Rear USB Connector**  
Connect this to a USB Memory/Portable audio player or to an iPod/iPhone. To use an iPod/iPhone, Interface cable for iPod connection is required.
- Notes**
- Use the supplied USB cable. If a USB cable other than the supplied is used, correct performance cannot be guaranteed.
  - Route the USB cable away from other cables.
- ④ **Antenna Receptacle**
- ⑤ **Audio Interrupt In Lead (Pink/Black)**  
Connect this lead to the Audio Interface output of a cellular phone which provides ground shorting when a call is received.
- ⑥ **Remote Turn-On Lead (Blue/White)**  
Connect this lead to the remote turn-on lead of your amplifier or signal processor.
- ⑦ **Switched Power Lead (Ignition) (Red)**  
Connect this lead to an open terminal on the vehicle's fuse box or another unused power source which provides (+) 12V only when the ignition is turned on or in the accessory position.
- ⑧ **Ground Lead (Black)**  
Connect this lead to a good chassis ground on the vehicle. Make sure the connection is made to bare metal and is securely fastened using the sheet metal screw provided.
- ⑨ **Power Antenna Lead (Blue)**  
Connect this lead to the +B terminal of your power antenna, if applicable.
- Note**
- This lead should be used only for controlling the vehicle's power antenna. Do not use this lead to turn on an amplifier or a signal processor, etc.
- ⑩ **Dimmer Lead (Orange)**  
This lead may be connected to the vehicle's instrument cluster illumination lead. This will enable the vehicle's dimmer control to dim the backlighting of the unit.
- ⑪ **Battery Lead (Yellow)**  
Connect this lead to the positive (+) post of the vehicle's battery.
- ⑫ **ISO Power Supply Connector**
- ⑬ **ISO Connector (Speaker Output)**
- ⑭ **Left Rear (+) Speaker Output Lead (Green)**
- ⑮ **Left Rear (-) Speaker Output Lead (Green/Black)**
- ⑯ **Left Front (+) Speaker Output Lead (White)**
- ⑰ **Left Front (-) Speaker Output Lead (White/Black)**
- ⑱ **Right Front (-) Speaker Output Lead (Grey/Black)**
- ⑲ **Right Front (+) Speaker Output Lead (Grey)**
- ⑳ **Right Rear (-) Speaker Output Lead (Violet/Black)**
- ㉑ **Right Rear (+) Speaker Output Lead (Violet)**
- ㉒ **Fuse Holder (10A)**
- ㉓ **Front Output RCA Connectors**  
RED is right and WHITE is left.
- ㉔ **Rear Output RCA Connectors**  
RED is right and WHITE is left.
- ㉕ **Subwoofer Output RCA Connectors**  
RED is right and WHITE is left.
- ㉖ **Power Supply Connector**
- ㉗ **RCA Extension Cable (sold separately)**
- ㉘ **BLUETOOTH INTERFACE Connection Cable (Included with BLUETOOTH INTERFACE)**
- ㉙ **ISO/JASO Antenna Adaptor (sold separately)**  
An ISO/JASO antenna adaptor may be required, depending on the vehicle.
- ⑳ **Front AUX Input Terminal**  
This terminal allows for input of audio from an external device (such as a portable player), using a commercially-available converter cable.
- ㉑ **Front USB Terminal**  
Connect this to a USB Memory/Portable audio player or to an iPod/iPhone. To use an iPod/iPhone, Interface cable for iPod connection is required.

**To prevent external noise from entering the audio system.**

- Locate the unit and route the leads at least 10 cm away from the car harness.
- Keep the battery power leads as far away from other leads as possible.
- Connect the ground lead securely to a bare metal spot (remove any paint, dirt or grease if necessary) of the car chassis.
- If you add an optional noise suppressor, connect it as far away from the unit as possible. Your Alpine dealer carries various noise suppressors, contact them for further information.
- Your Alpine dealer knows best about noise prevention measures so consult your dealer for further information.